



MAGNUM[®]



Operating Instructions

Magnum Original 6,0kW - 6,6kW - 9,0kW - 10,5kW

Magnum Lite 6,0kW - 6,6kW - 9,0kW - 10,5kW

Magnum Cenik 6,6kW - 9,0kW

Magnum Sade 6,0kW - 9,0kW

These instructions are intended for the owner of the sauna or the person responsible for its maintenance, as well as for the electrician who installs the sauna stove. The electrician will give these instructions to the owner of the sauna or the person responsible for its maintenance after the stove has been installed successfully. The owner of the sauna stove or the person responsible for its maintenance must store these instructions for the entire lifespan of the sauna stove, because changes may be made to the components. Keeping the original instructions ensures that the circuit diagrams and the connection methods used during maintenance works are intended for this particular sauna stove.

The owner of the sauna must read these instructions carefully before first using the sauna stove. The instructions contain full operating and maintenance instructions, installation instructions, a troubleshooting guide and the warranty terms for the sauna stove and its parts.

The electrician must ensure that the device has been disconnected from the power supply before performing any installation or maintenance work. The fitter should avoid touching the internal components and integrated circuits of the device unnecessarily. Touching can result in a discharge of static electricity, which may damage the device or one of its electrical components. The electrician must ensure that the device is grounded correctly and that all connections have been completed according to the instructions.

The only purpose of this sauna stove is to heat the sauna to a suitable sauna temperature. The sauna stove must not be used for any other purpose. You must never put anything else than water ontop of the heater. User of sauna must allways check sauna before turning it on.

TABLE OF CONTENTS

1.	Using the device – Finlandia Control Center.....	4
1.1	– Control Functions – Finlandia Control Center.....	4
1.2	– Menu Structure.....	5
2.	Using the sauna Stove.....	6
2.1	– Turning the heater on.....	6
2.2	– Turning sauna lights on.....	6
2.3	– Target temperature adjustment.....	7
2.4	– Heating time adjustment.....	7
2.6	– Timer.....	8
2.7	– Control panel default mode when device is turned on.....	8
2.8	- Directions for using the sauna.....	9
3.	Installation of the sauna stove.....	10
3.1	– Installation Stages.....	11
3.2	- Thermostat sensor.....	14
3.3	– Finlandia control panel installation.....	15
3.3.1	- Surface Installation:.....	15
3.3.2	– Recessed mount:.....	16
4.	Installation illustrations and renderings.....	18
4.1	- Thermostat and controller – Installation in the sauna.....	18
4.2	- Mechanical ventilation.....	19
4.3	- Natural gravitational ventaltion.....	20
4.4	– Pilling the stones in to heater – Magnum Original, Lite, Cenik.....	21
4.5	- Pilling the stones in to heater – Magnum Sade.....	23
4.6	– Sauna stove wall bracket.....	24
5.	Technical information and safety distances of the sauna stoves.....	25
5.1	- Illustration of safety distances.....	25
5.2	- Physical measurements and technical specifications of the sauna stoves.....	26
5.3	- Upper parts: size table.....	28
6.	Warranty – TERMS APply only in finland.....	29
7.	Connection diagram.....	30
8.	Sauna stove care and maintenance.....	31
9.	Problems/troubleshooting guide.....	32

1. USING THE DEVICE – FINLANDIA CONTROL CENTER

1.1 – CONTROL FUNCTIONS – FINLANDIA CONTROL CENTER

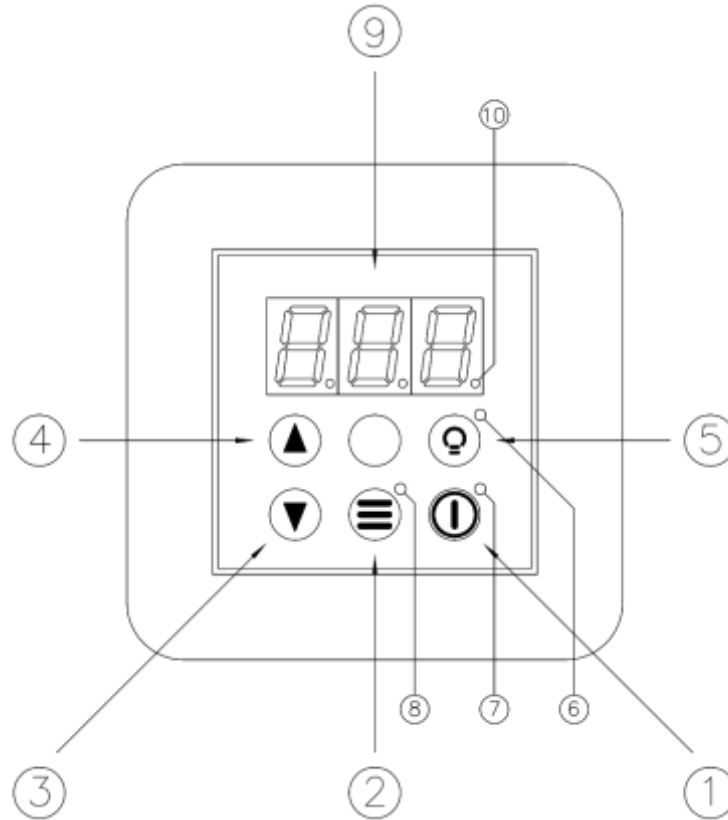

1. On/Off button. Pressing this button turns the sauna stove on and off. If the timer has been set, pressing this button starts the timer for heating the sauna.
2. Menu button: by pressing this, you can move through the menus of the device as follows: Default mode → Target temperature → Heating time → Timer → Default mode)
3. Downwards button. This button is used to decrease the default values
4. Upwards This button is used to increase the default values.
5. Lights button: by pressing this, you can turn on the sauna stove's light. Pressing it again turns the light off. (Only used in models with lights or a separate fibre kit)
6. Sauna stove light's indicator light. This light is on as an indicator of the fibre light kit of the sauna stove / sauna being on.
7. "Device on" indicator light. This light is constantly on while the sauna stove is on. The light "glows" when the timer is in use. The light is turned off when the sauna stove is not on.
8. Menu settings indicator light. This light comes on when a menu setting is adjusted. (timer, the time the device is on, the target temperature of the sauna stove)
9. Three digit display.
10. Heating resistor indicator light. When light is on, that means that control center is heating saunaroom and heating resistors have full power on. If light turns off while heating saunaroom, that means saunaroom has reached its target temperature and resistors will be turned off.

1.2 – MENU STRUCTURE

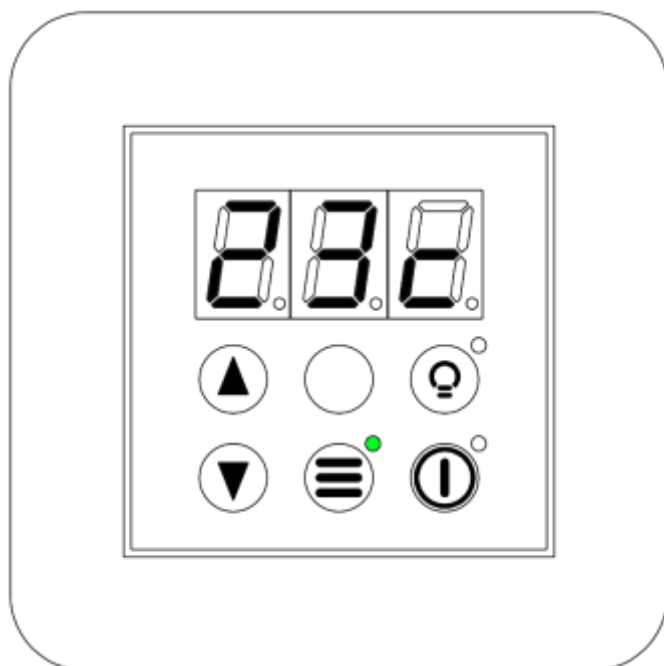

In the default mode, three digit display will show saunaroom temperature. In 2024, an energy-saving mode has been added to the control panel, where the temperature display is turned off. When active, green light flashes for one second every five seconds. By pressing any button, the control panel returns to normal mode from the energy-saving mode.

Press once – Target temperature

Press Twice – Heating time

Press trice - Timer

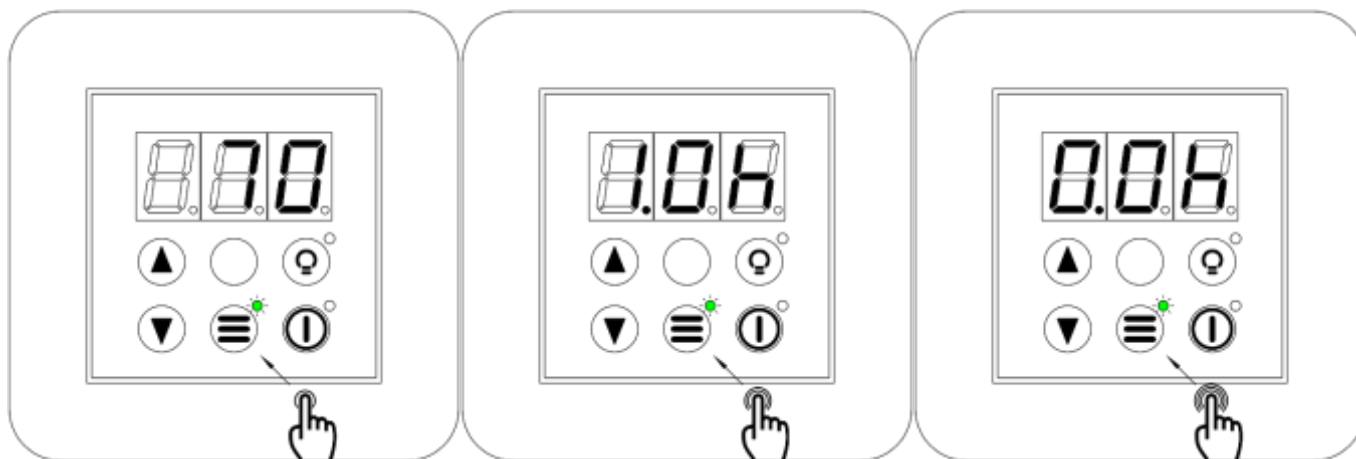

The adjustment menus of the device are shown in the image above. The user can move from one menu to another using the Menu button. When the sauna stove is on, the (▲) and (▼) buttons can be used to adjust the settings, as shown in the image above. When menu is active, there will be green light on right side of menu button.

2. USING THE SAUNA STOVE

2.1 – TURNING THE HEATER ON

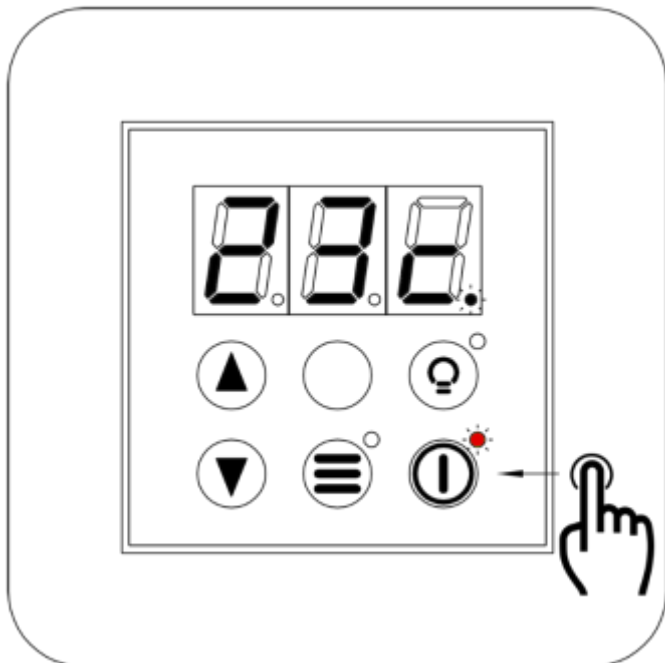

Make sure that control switch is on in power unit. Make sure that the sauna stove is not covered, and that there is nothing in the sauna that does not belong there. Pressing the Controller's On/Off button makes the sauna stove start heating until the target temperature has been reached. The stove heating indicator light in the controller will switch on. The decimal mark lights up on the lower right side of the screen to indicate that the resistors are on. (If the timer has been set, the On/Off button turns the timer on and the sauna stove begins heating only after the timer has run out). The On/Off button turns the sauna stove off.

2.2 – TURNING SAUNA LIGHTS ON

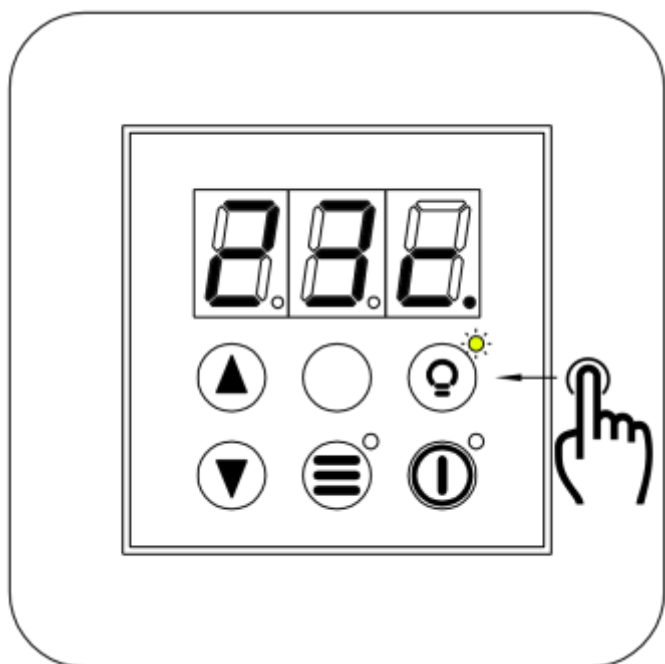

If there are lights in the sauna stove or if other sauna lights are controlled through the sauna stove, the lights are turned on from the control panel's light switch. The light switch is located to the right top of the keypad, just above the stove power switch. The lights remain on even if the sauna stove is off, unless they are specifically turned off from the control panel's light switch. If power has been taken from the sauna stove for lights other than those of the stove, and they only light up when the stove heats up, the lights have been installed in the wrong place on the circuit board.

2.3 – TARGET TEMPERATURE ADJUSTMENT

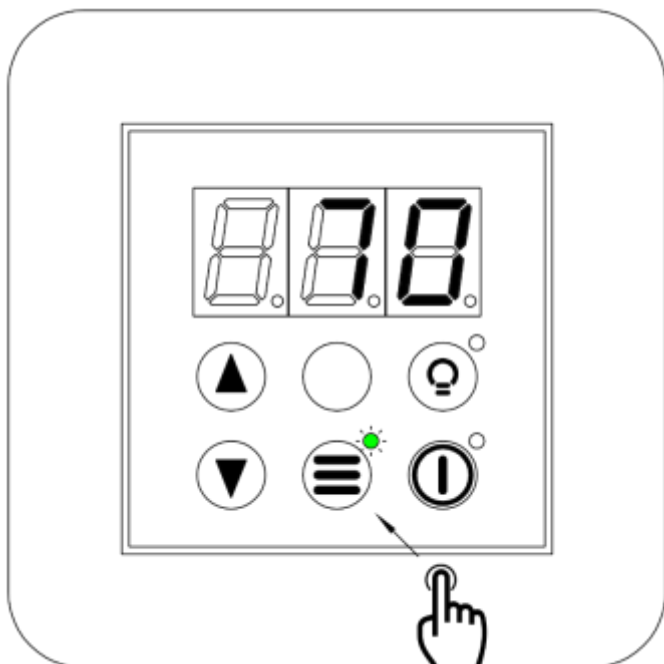

The sauna's target temperature can be adjusted with one-degree Celsius precision. The minimum is 40 degrees, and the maximum is 110 degrees. The setting is saved in memory. The default target temperature is 60°C.

To adjust the temperature, press the Menu button once, and the target temperature will appear on the display.

The target temperature is adjusted by pressing the \wedge and \vee buttons. The controller automatically exits the target temperature setting menu after about 10 seconds if no button is pressed. You can also manually exit the menu by repeatedly pressing the Menu button.

Tip: You can also adjust the temperature in the basic mode by pressing the \wedge and \vee buttons. You don't need to adjust the temperature through the menu when the sauna stove is already on.

2.4 – HEATING TIME ADJUSTMENT

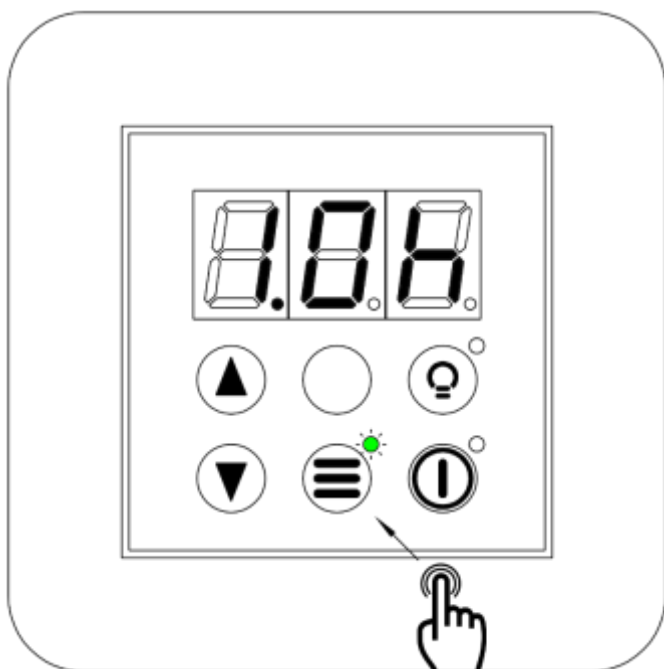

You can set the sauna stove's heating time to be between 1 h and 6 h. The adjustment takes place in increments of 0.5 h. The time value has to be set when the device is turned off. You can move to this setting from the default mode by pressing the Menu button twice.

It is possible to reduce the time the stove is on when the sauna is heating. You can increase or decrease the time of the sauna session by pressing the (\wedge) or (\vee) button when the remaining time is on the display. In this case, the adjustment increment is 15 min. This setting is not saved to the memory. This setting can also be changed by pressing the Menu button twice in default mode.

2.6 – TIMER

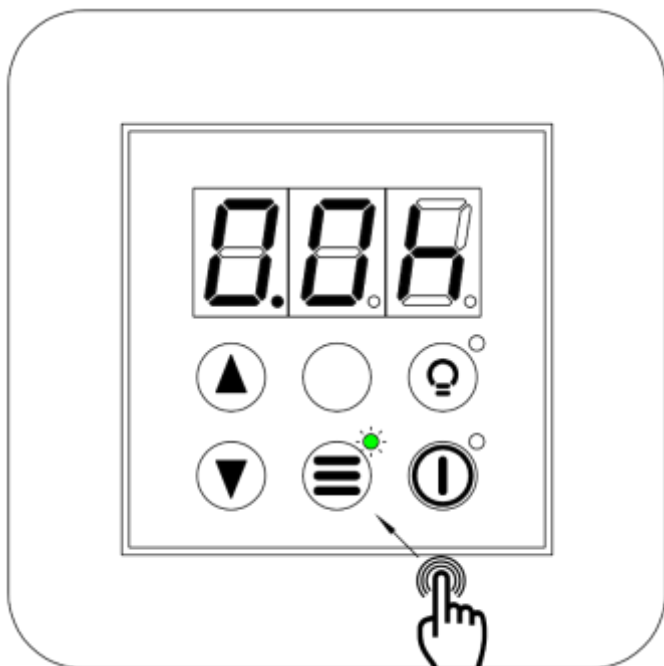

You can move from the default mode to the timer by pressing the Menu button three times in a row. The (^) and (v) buttons are used to change the timer's setting. The adjustment range is 0.5 h – 24 h, and the adjustment increment is 0.5 h. If this value is zero, the timer is not in use.

This setting can only be changed when the device is off.

2.7 – CONTROL PANEL DEFAULT MODE WHEN DEVICE IS TURNED ON

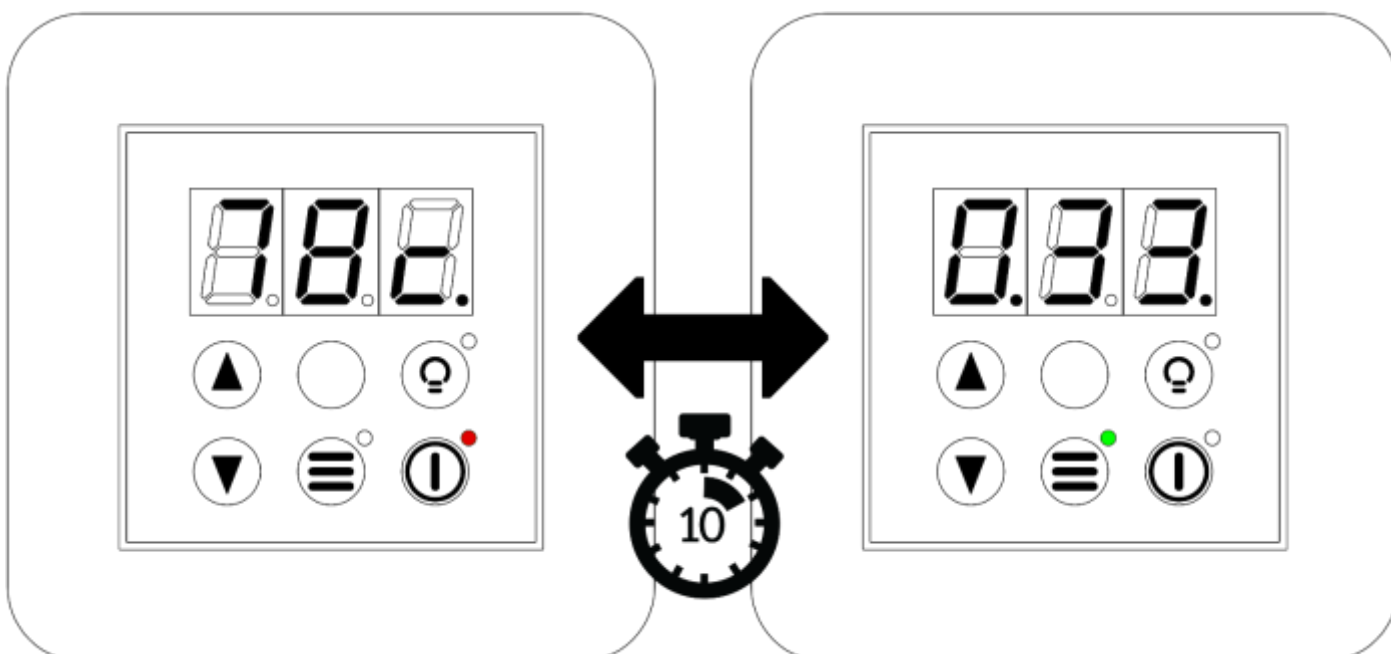

When the device is on, the display alternates between basic mode (temperature display) and remaining time. The display alternates approximately every 10 seconds.

2.8 - DIRECTIONS FOR USING THE SAUNA

- Heat the sauna stove once before first use, as the protective substances in the new stones may give off odours while the sauna stove is heating. Ensure there is sufficient ventilation. After the heating is completed, open the sauna window (if applicable).
- Make sure that the sauna stove has not been covered, and that there is nothing in the sauna that does not belong there (laundry, children's toys, etc.)
- The recommended temperature is 55 – 70 degrees.
- The sauna stove heats to a suitable sauna temperature in approx. 25 – 80 minutes, depending on the size of the sauna stove, the size of the sauna, and the ventilation.
- Use water that is suitable for domestic use when throwing water on the sauna stove. The use of seawater is forbidden.
- Do not throw water on the sauna stove if there are people next to it, as the water splashing from the sauna stove and the steam it creates are scalding hot.
- Move carefully in the sauna, as the floors may be slippery.
- The manufacturer recommends heating the sauna stove until hot, and turning it off at the beginning of the sauna session. It will spare the resistors considerably if cold water is not thrown on a resistor glowing red-hot. The mass of stones will keep the sauna hot for a long time, and “once-off heating” enables to have a sauna session of about 20 – 30 min before the sauna stove has to be switched on again.

Quality requirements for the heating water

Water condition:	Effect:	Recommendation:
Water containing humus	Colour, taste, deposits	<12 mg/l
Water containing iron	Colour, odour, taste, deposits	<0.2 mg/l
Hardness: the most important substances are manganese (Mn) and chalk or calcium (Ca)	Deposits	Mn: <0.05 mg/l Ca: <100 mg/l
Water containing chloride	Health risk	Use is banned
Seawater	Fast corrosion	Use is banned

3. INSTALLATION OF THE SAUNA STOVE

- **The electrical installation may only be performed by a qualified electrician**
- **Instructions for the electrical installation are provided in the circuit diagram in these installation instructions as well as on the sticker on the sauna stove.**
- **The electrical installation work may only be performed by an electrician qualified for the job, in accordance with applicable regulations.**
- The sauna stove is connected to the power grid semi-permanently with H07RN-F or similar rubber cable.
- Check the required cable dimensions in the table below.
- **Please note! The use of a PVC cable as a connection cable is not permitted.**
- **The power switch in the device is a so-called control switch, and it does not fully de-energise the sauna stove.**

HEATER	POWER	FUSES	FEED CALBE	SAUNA SIZE
Magnum 6	6,0kW	3x10 A	5x1,5mm ²	5-8m ³
Magnum 6,6	6,6kW	3x10 A	5x1,5 mm ²	5-9 m ³
Magnum 9	9,0kW	3x16 A	5x2,5 mm ²	8-15 m ³
Magnum 10,5	10,5kW	3x16 A	5x2,5 mm ²	10-20 m ³

3.1 – INSTALLATION STAGES

1. Remove the stainless steel frame from the upper part of the sauna stove - Original, Lite, Cenik models. Sade heater has no removable parts.
2. Remove the protective plastics from the metal parts.
3. Fold the sauna stove's cardboard box up and set the sauna stove on its side on the cardboard. Ensure that the sauna stove does not become scratched.
4. Open the hatch at the base of the sauna stove.
5. Feed the Finlandia panel wire (8x0.25 mm² LYII grey cable) through the lowest cable gland and connect the wires on the circuit board on the terminal block with the numbers 1-8. The terminal block can be detached from the main board for easier installation. The terminal block is located in the lower left section. Tighten the cable gland after the installation is complete.

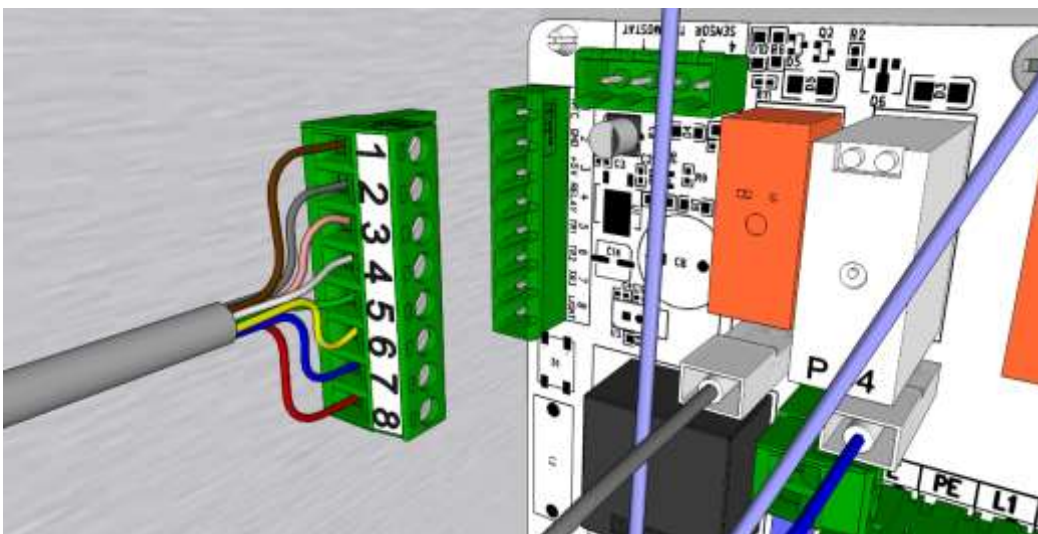

Order of wires to board

1. Brown
2. Grey
3. Pink
4. White
5. Green
6. Yellow
7. Blue
8. Red

6. Connect the thermostat sensor according to **SECTION 3.2**. Feed the thermostat sensor wire (4x0.25 mm² silicone cable, beige wire) through the second-lowest cable gland and connect the wires on the circuit board, to the 4-slot terminal block adjacent to the Finlandia panel block. The terminal block can be detached from the main board for easier installation. Tighten the cable gland after the installation is complete.

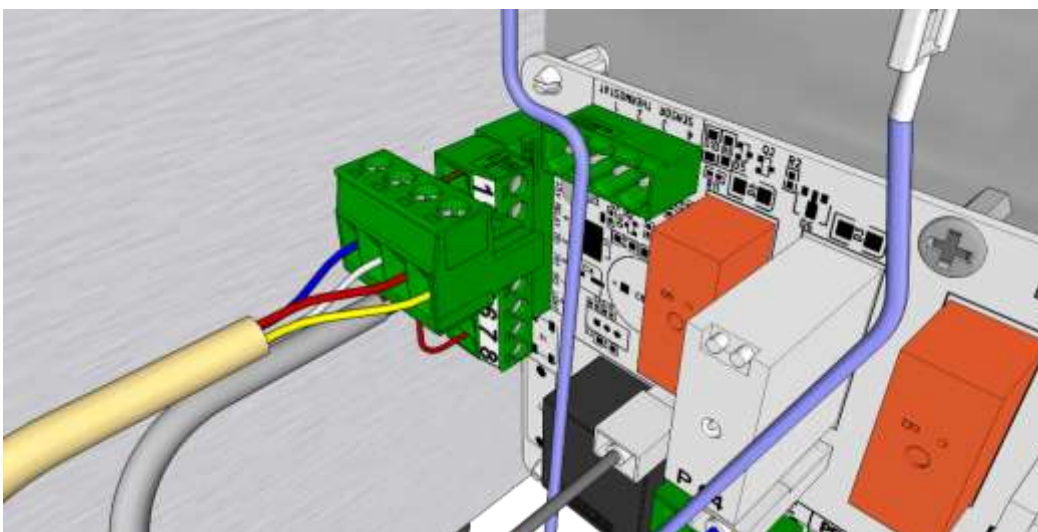

The wire order on the board, from right to left.

1. Blue
2. White
3. Red
4. Yellow

PLEASE NOTE! If the wire needs to be shortened, shorten it from the stove's side. The wire must not be continued.

7. Feed the supply cable through the upmost cable gland and connect the feeder line to the quick connector on the circuit board. Wires with glands can be pressed directly into the connector, otherwise, the spring lever might have to be loosened. Tighten the cable gland after the installation is complete. Connections go from left : PE, PE, L1, L2, L3, N. Depending on version, connections can be marked with UL version as : GR, GR, L1, L2, L3, N.

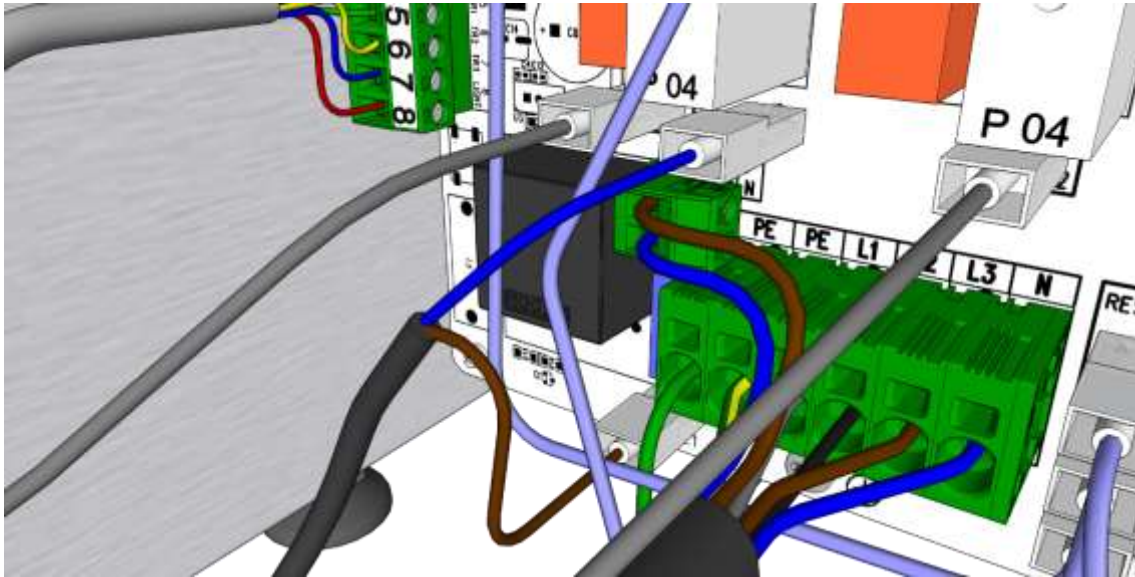

8. Temperature reduction (Connector J5) (the lower connector on the photo above). If this feature is in use, it is possible to connect a relay or contactor coil to the output, which controls the heating of the building. It is recommended to use a seven-stranded cable for wiring the sauna stove. Detach the connector from the circuit board and screw the cables to the connector. Then, press the connector back onto the circuit board.
- P – 230VAC OUT – Brown above
 - N – External – Blue below
9. If the sauna stove is intended to power sauna lamps as well, install the cable gland M20/10 (e.g. e-number [1704106](#)). The lights connector is located in the middle left. **The maximum strength of lamps is 100W/0.5A** If temperature reduction is taken, you must buy separate connector to get lights from heater, please contact seller of the heater.
- P – 230VAC OUT – Brown above
 - N – External – Blue below

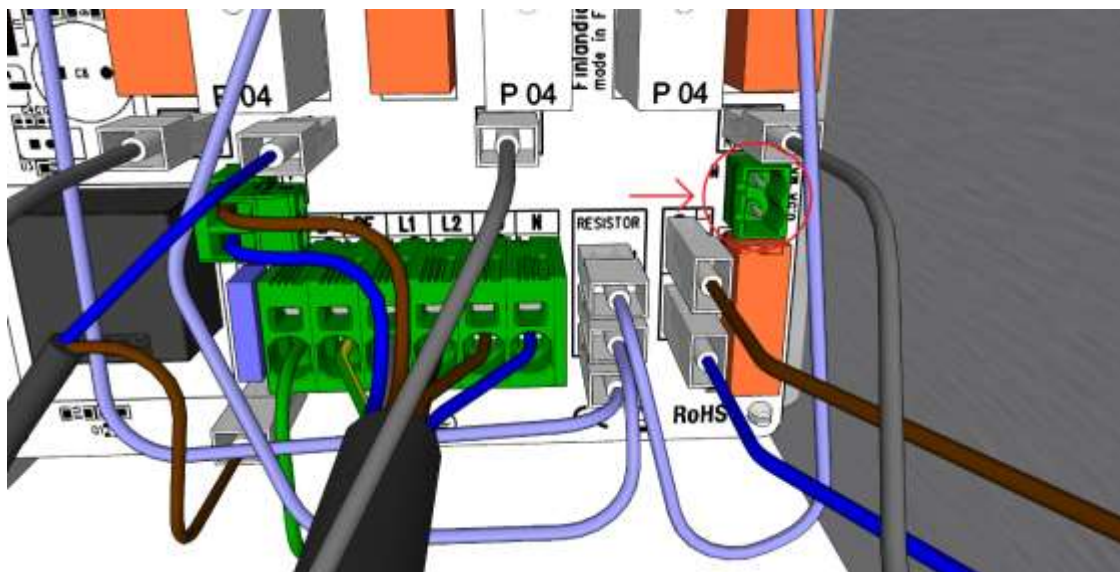

10. Close the hatch on the base of the sauna stove.
 11. Install the Finlandia control panel in accordance with **CHAPTER 3.3**. Wiring instructions for the panel below.

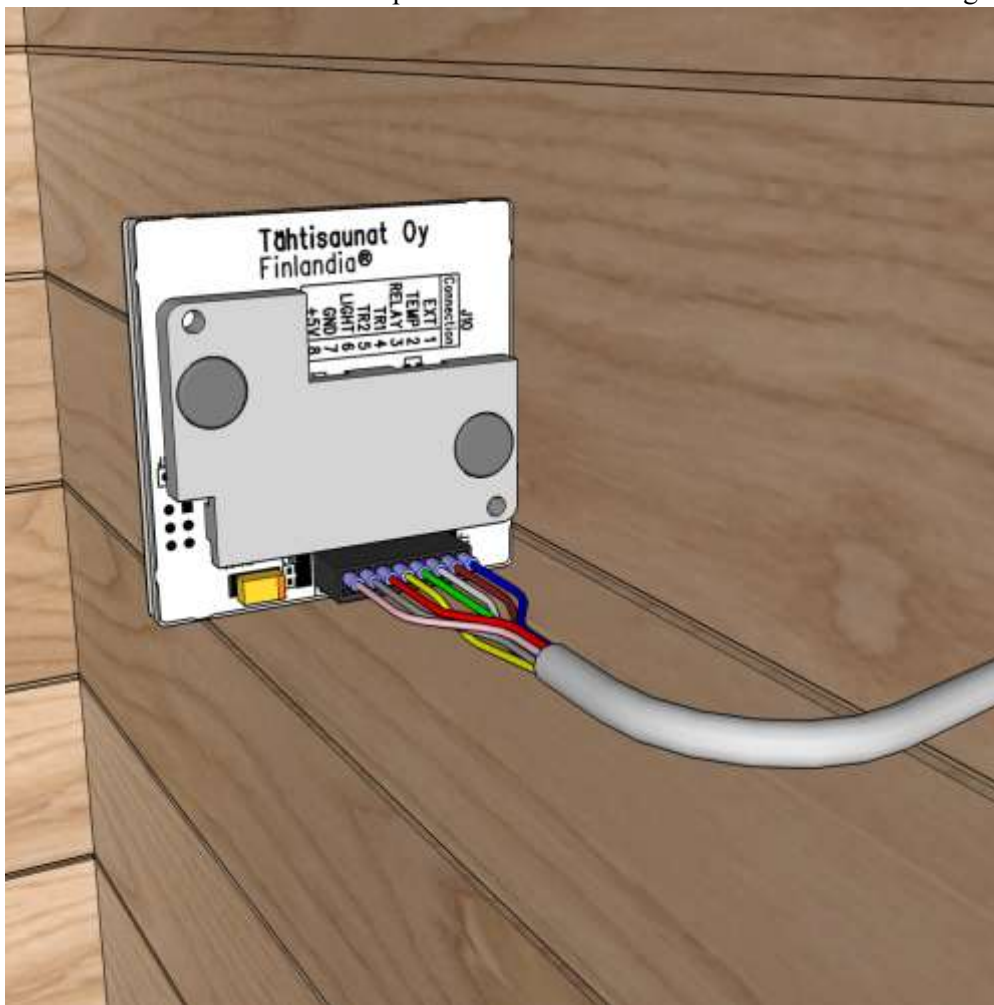

From left to right, viewed from behind:

8. Pink
7. Grey
6. Red
5. Yellow
4. Green
3. White
2. Brown
1. Blue

The panel wiring is not identical to the control centre wiring, because we wish to keep the product compatible with old systems.

It is not recommended to shorten wires from the panel's side, as the wires have been fitted with quick connectors. If necessary, shorten the wires from the centre's side.

12. Feed the other end of the supply cable to the electrical box. Please note that the maximum height of the junction box is 400 mm
13. Put the control switch into position I
14. Test resistor functionality by turning the sauna stove on. If all the resistors do not heat or if there is another issue, contact the retailer or technical support.
15. Install the lower part of the sauna stove, taking the safety distances into consideration. Adjust vertically, using the adjustment feet.
16. Pile the stones in the sauna stove in accordance with **CHAPTER 4.4**.
17. The sauna stove must be heated once before people use it for the first time, and the sauna must be thoroughly ventilated afterwards. There may be impurities in the stones, and some residue of storage/machining lubricants on the sauna stove, the traces of which will disappear during the first heating. Also monitor the settling of the stones after the first heating, and add more stones on top, if necessary.

3.2- THERMOSTAT SENSOR

THERMOSTAT SENSOR

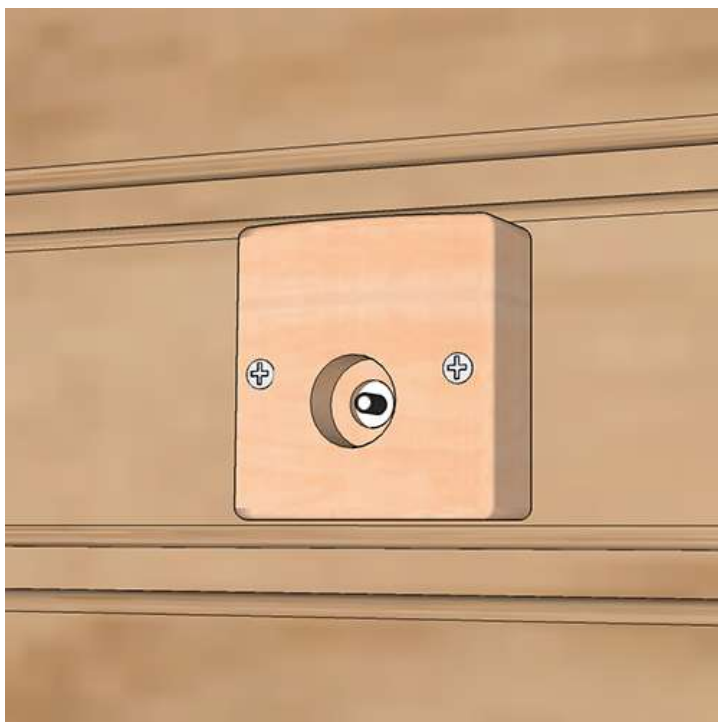

THERMOSTAT SENSOR WIRE AND CONNECTOR

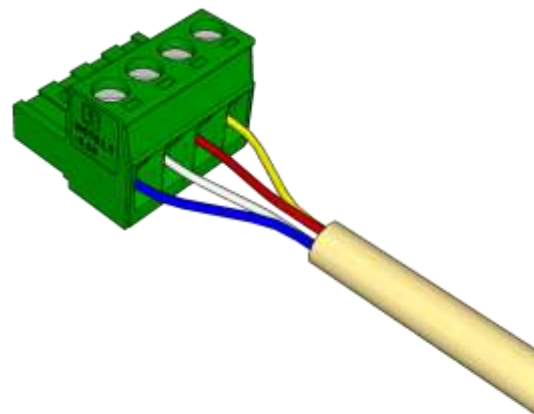

CONNECTING THE WIRES

To the connector	Blue	White	Red	Yellow
To the circuit board	1	2	3	4

The thermostat sensor is wooden, its external casing is made from black alder.

The external casing can be painted to match the sauna panels using sauna wax, but remember to detach all electronic components from the sensor before painting. Electronic components could be damaged by paint.

Connect the connector to the designated connector on the circuit board, press the connector carefully all the way down.

Thermostat sensor are installed on the wall so that the distance between the ceiling and the upper edge of the sensor is 100 mm. The sensor must be located 500 – 1000 mm from the upper edge of the sauna stove. Furthermore, the sensor must be located at least 1000 mm from a non-directed incoming air valve or 500 mm from an incoming air valve which is located away from the device. **Illustration SECTION 4.1**

Install the thermostat cable behind the panel in the air vent; if this is not possible, use an installation baseboard. Make sure that the incoming air does not disturb the heat sensor.

Do NOT cut the wire from the thermostat's side. The thermostat sensor does not function if the wires are continued/reconnected. If the wire needs to be shortened, shorten it from the connector's side. In other cases, contact the technical support.



3.3 – FINLANDIA CONTROL PANEL INSTALLATION

There are many installation options for the Finlandia control panel. The maximum height of the control panel from the floor of the sauna or the washroom floor is 1000 mm. The requirements of the electrical wiring standard SFS 6000, sections 7-701, are applicable to the washroom. The ingress protection of the Finlandia panel is IPX4. The standard length of the control panel's wire is 10 metres.

3.3.1 - SURFACE INSTALLATION:

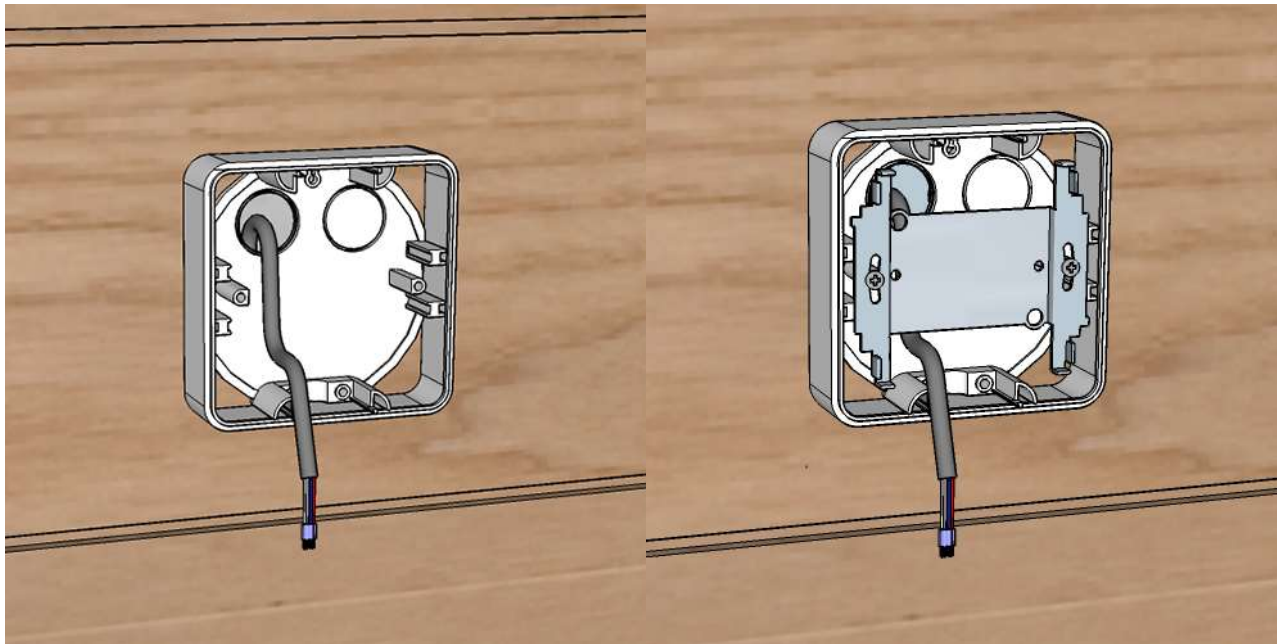

In the sauna: Install the surface box at a max height of 1000mm from the floor, and bring the wire out of the box. Screw the panel's mounting bracket to the box. **In the washroom:** no height restrictions, but the recommended height is 1500mm or at the same height as the light switches.

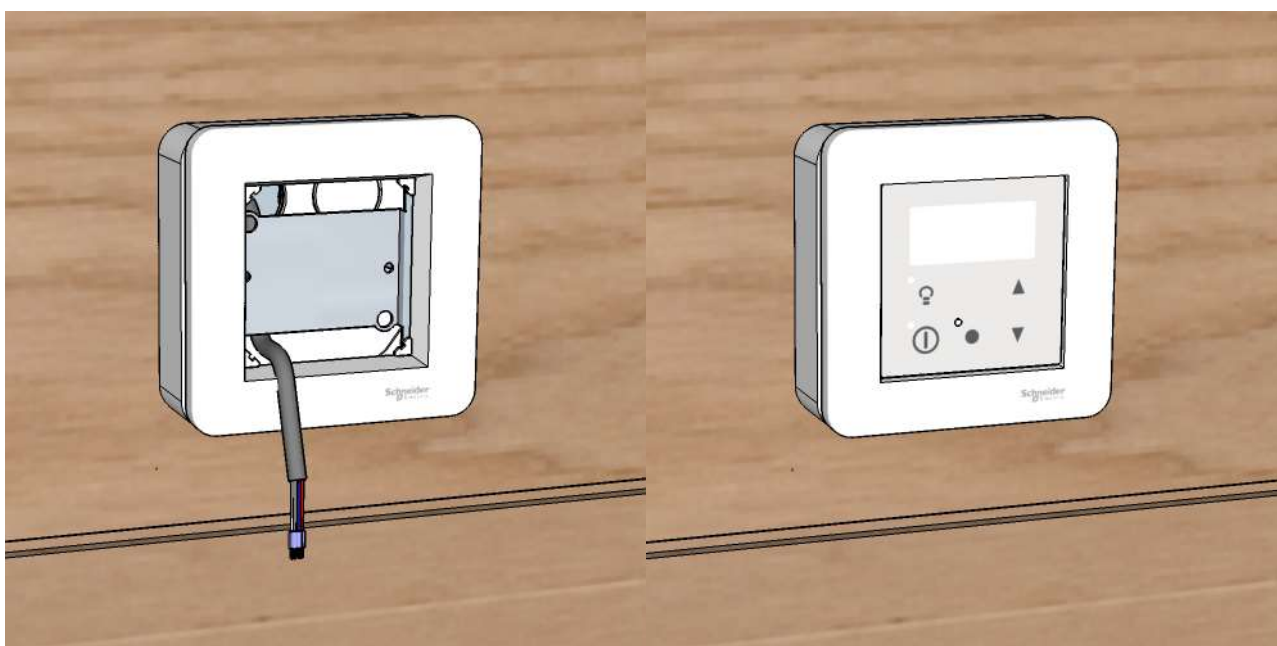

Place the frame on the bottom of the box, connect the wires to the panel, and press the control panel to fasten it in the middle of the frame. The panel will be attached to the bracket with magnets. Wiring instructions on page 11.

3.3.2 - RECESSED MOUNT:

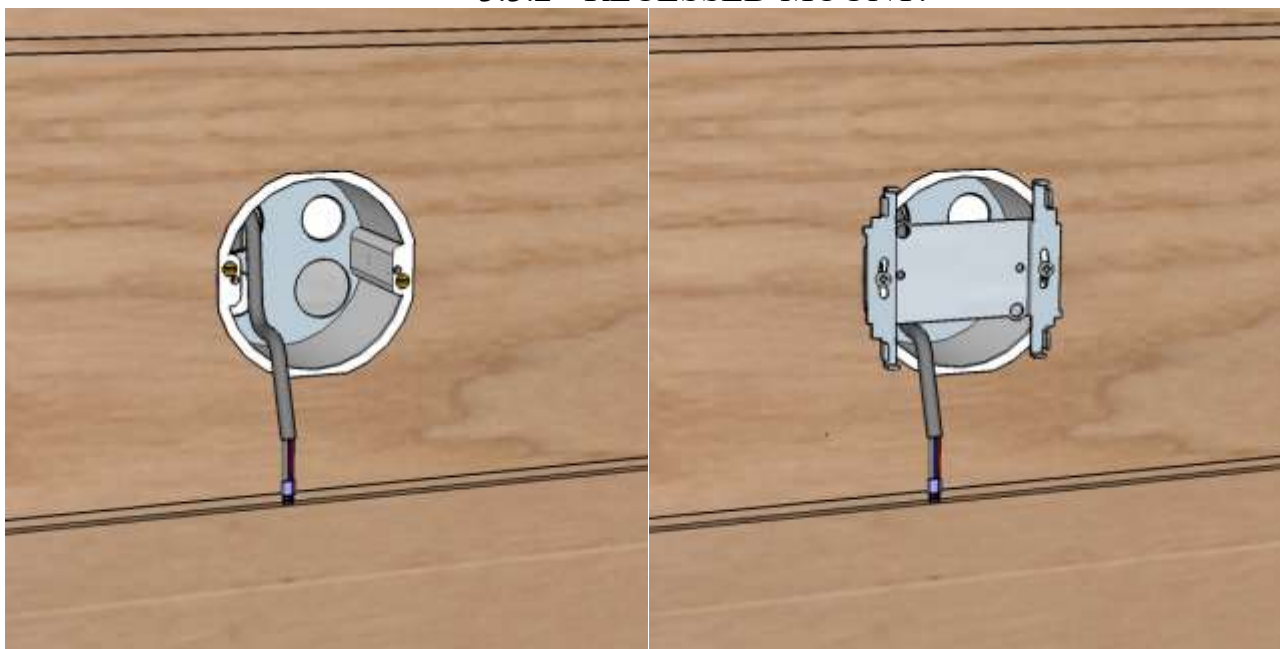

In the sauna: Drill a hole in the panel for the recess box. Be careful not to drill all the way to the insulation. Panel max height in the sauna 1000mm from the floor. Bring the panel wire out of the box. Screw the panel's mounting rod to the box. **In the washroom:** no height restrictions, but the recommended height is 1500mm or at the same height as the light switches. When installing on a tiled surface, recessed mounting has to be taken into consideration already during the construction stage. Suitable box e.g. ABB AUS 15.2 "Renovation box". Hole 70mm – Box drill AT1.

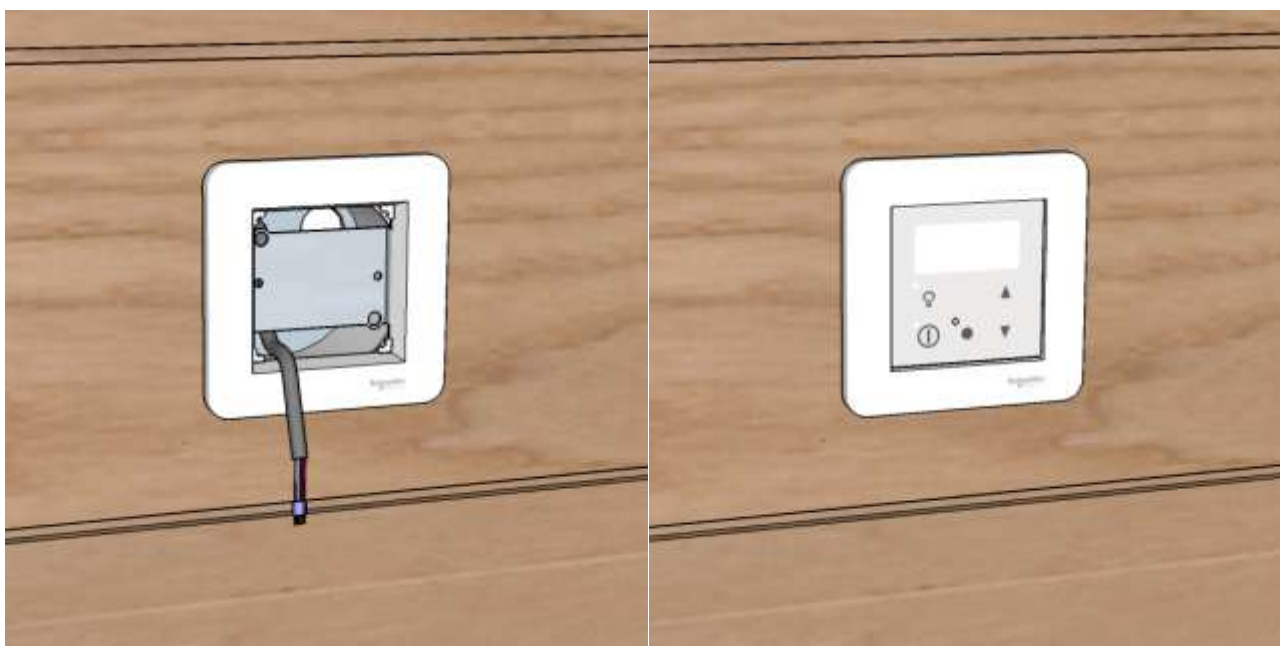

Place the frame on the bottom of the box, connect the wires to the panel, and press the control panel to fasten it in the middle of the frame. The panel will be attached to the bracket with magnets. Wiring instructions on page 11.

The panel can be integrated into the light switches using a double frame. Any frame from the Schneider Electric Exxact range can be used.

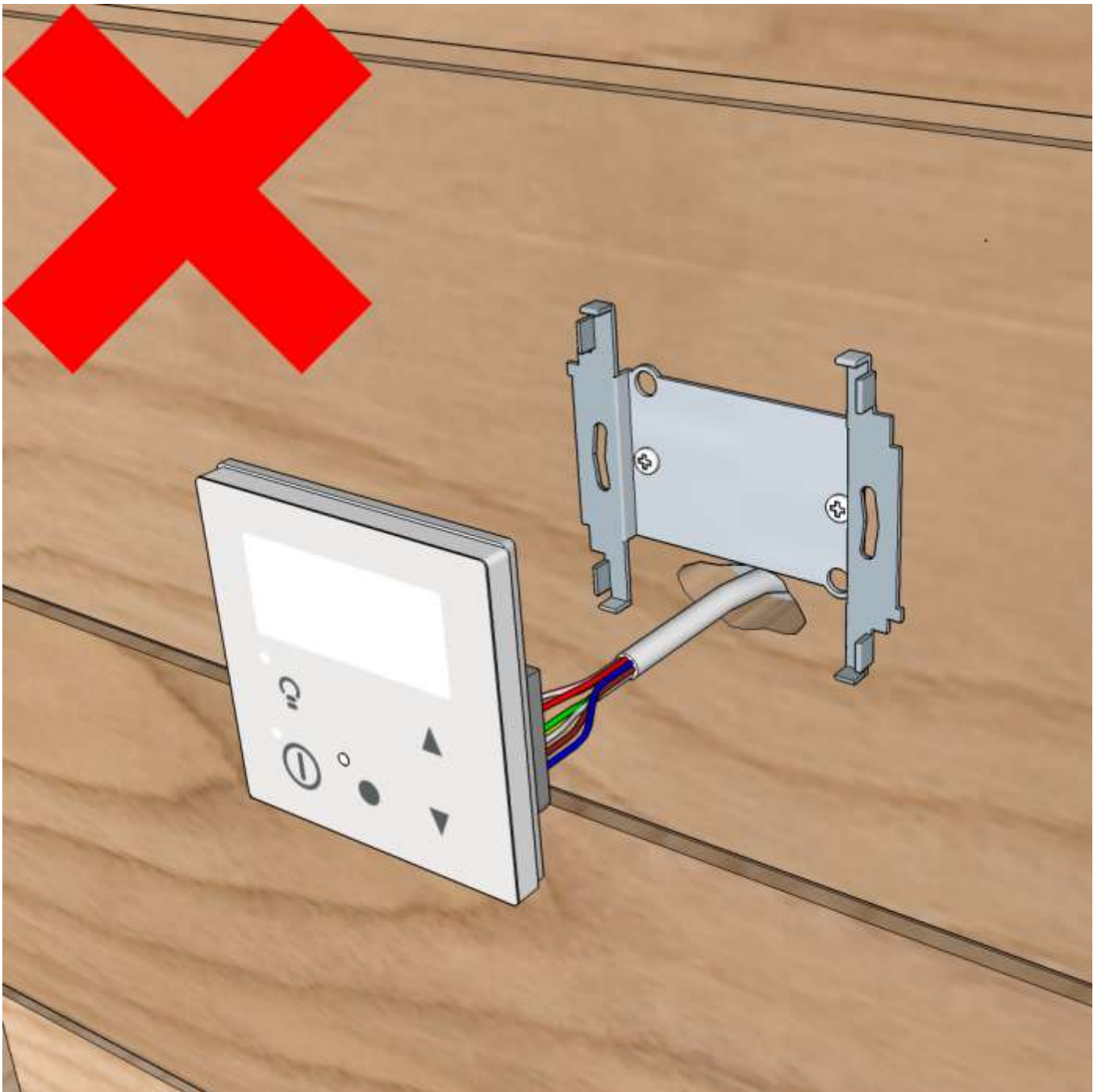

The panel can't be installed without a surface or flush-mounted box. The warranty of the center will be void if the panel is installed contrary to the instructions.

In the sauna and bathroom, the box must be IP44 rated, for example, WDE002851 or equivalent, and installed with sealing kit WDE002870.

For recessed mount installations, use sealing kit WDE002870 when installing in a sauna or other wet area.

For dry areas, a surface-mounted box such as WDE002751 or equivalent is suitable.

4. INSTALLATION ILLUSTRATIONS AND RENDERINGS

4.1- THERMOSTAT AND CONTROLLER – INSTALLATION IN THE SAUNA

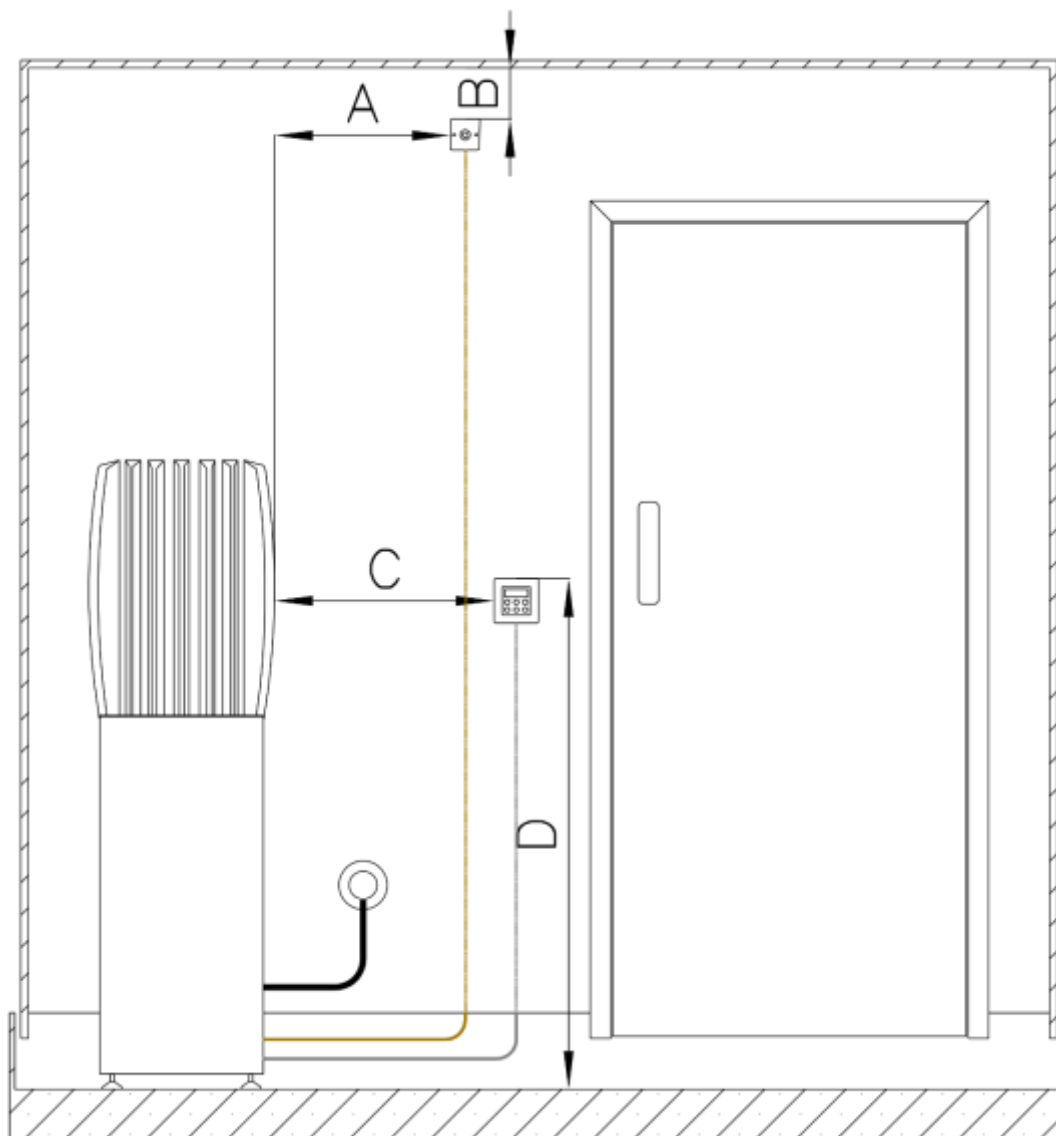

- A. The distance of the thermostat from the outer edge of the sauna stove is 500 – 1000 mm. **PAY ATTENTION TO THE INCOMING AIR VALVE.** If incoming air cannot be directed away from the thermostat, the valve may not be installed **less than 1000 mm** from the incoming air valve. If it can, the installation distance may be between 500 mm - 1000 mm.
- B. The distance of the thermostat from the ceiling is 100 mm.
- C. The minimum distance of the control panel from the sauna stove is 500 mm.
- D. The maximum height of the control panel from the floor is 1000 mm.

4.2- MECHANICAL VENTILATION

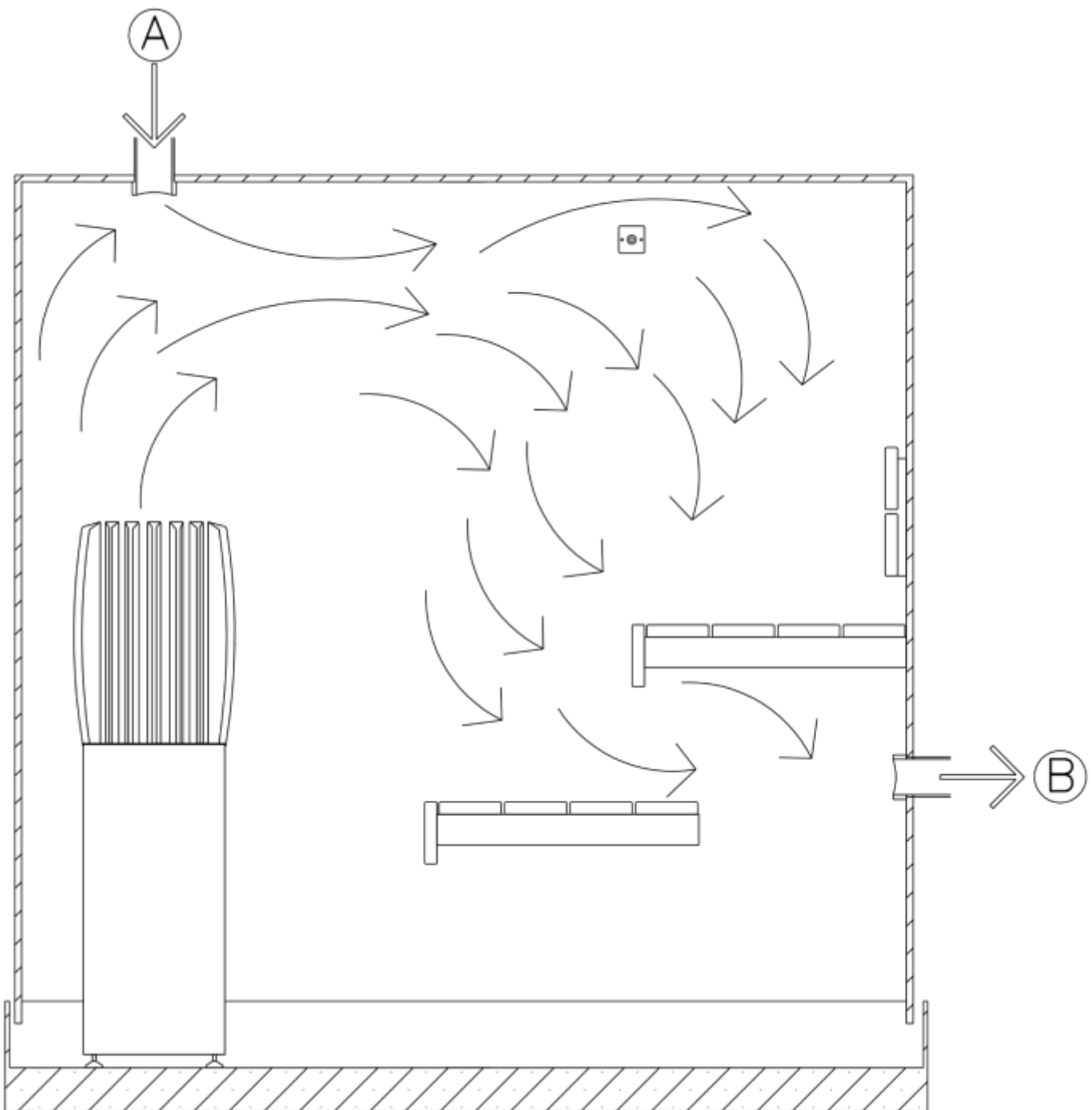

It is recommended that incoming air is directed straight on top of the sauna stove, so that fresh air can be distributed in the steam room with the steam. Air should be replaced six times per hours.

A- Supply air

B- Exhaust air

4.3 - NATURAL GRAVITATIONAL VENTALATION

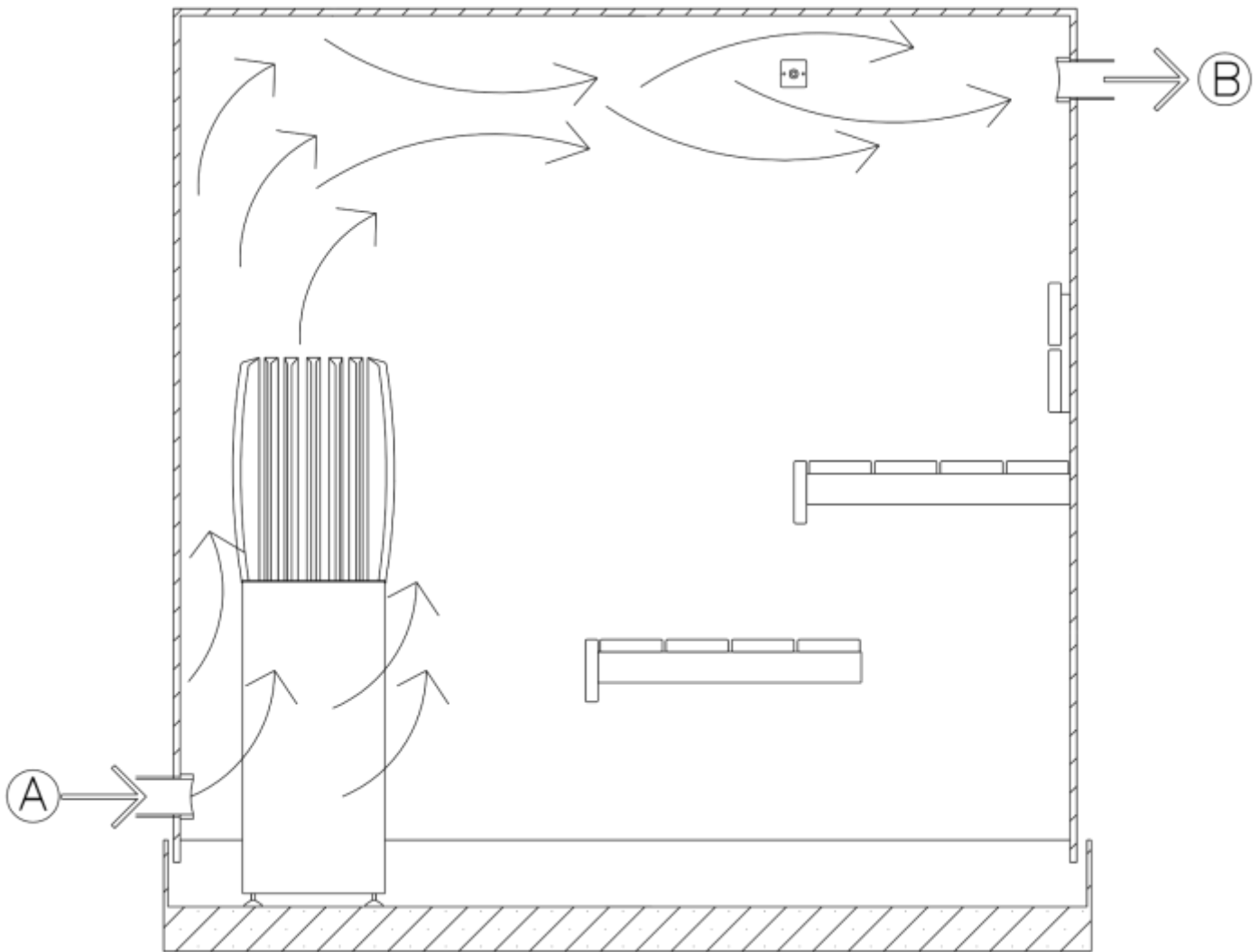

With natural gravitational ventilation, the supply air should be either on the floor, or low on the wall next to the sauna stove. The exhaust air can be on the wall or on the ceiling. The outlet valve should be closed during a sauna session, to keep the heat in the sauna. The valve is opened after a sauna session, to let the sauna dry. Air can partially escape also to the washroom, if there is a sufficiently large gap underneath the door.

- A- Supply air**
- B- Exhaust air**

4.4– PILING THE STONES IN TO HEATER – MAGNUM ORIGINAL, LITE, CENIK

Preparations:

1. Ensure that the sauna stove is correctly connected and that the resistors definitely heat up. **Do not pile stones in the sauna stove if the sauna stove does not work fully!**
2. The benches should be installed before the stones are piled in the sauna stove, particularly if the sauna stove is integrated through the benches.
3. Place the sauna stove in its intended location, considering the safety distances. Straighten the sauna stove, using the adjustment feet.
4. For piling stones in the sauna stove, you will need a spirit level, protective gloves, 70 – 150 kg of rocks with a diameter of 5 – 10 cm (depending on the sauna stove model, **see section 5.2**), specifically rocks intended for use in the sauna stove, for example olivine diabase, olivine or peridot. Wash the rocks, if necessary.
5. In the installation illustrations, the parts of the sauna stove have been rendered in different colours and transparent, to make the instructions clearer.

Stone piling stages:

Please note! It is advisable to have small, smooth stones ready for piling in the upper section. Large stones will be placed in the lower section.

1. Make sure the stones are not tumbled on the sauna stove bottom. Do not wedge the resistors. Ensure that the resistors remain vertical throughout the entire stoning process. Do not pack the stones tightly. **Ensure that there are stones also between the resistors.**
2. If you have reached about 50mm above the bend in the middle of the resistors, drop the first resistor plate on top of the stones. This plate will help the resistors stay upright, and prevent them from moving as the stones sink.
3. Continue piling stones in the sauna stove until you have reached about 60mm from the highest section of the lower part. In LITE/CENIK models put the casing between the upper and lower part in its place. In the Original model, the casing is fixed, as the fibre lights are connected to it. Put the upper part in its place. Put brackets 4 pcs in place to hold upperpart in place.
4. Pile the sauna stove with stones until you have reached approx. 50 mm below the highest point of the resistors.
5. Lower the upper resistor plate on the stones. This plate will help the resistors stay upright, and prevent them from moving as the stones sink. If necessary, install the sauna stove's wall brackets in accordance with **SECTION 4.5**.
6. Finish piling stones in the sauna stove. The stones on the top should be tightly packed. You should put large stones on top.



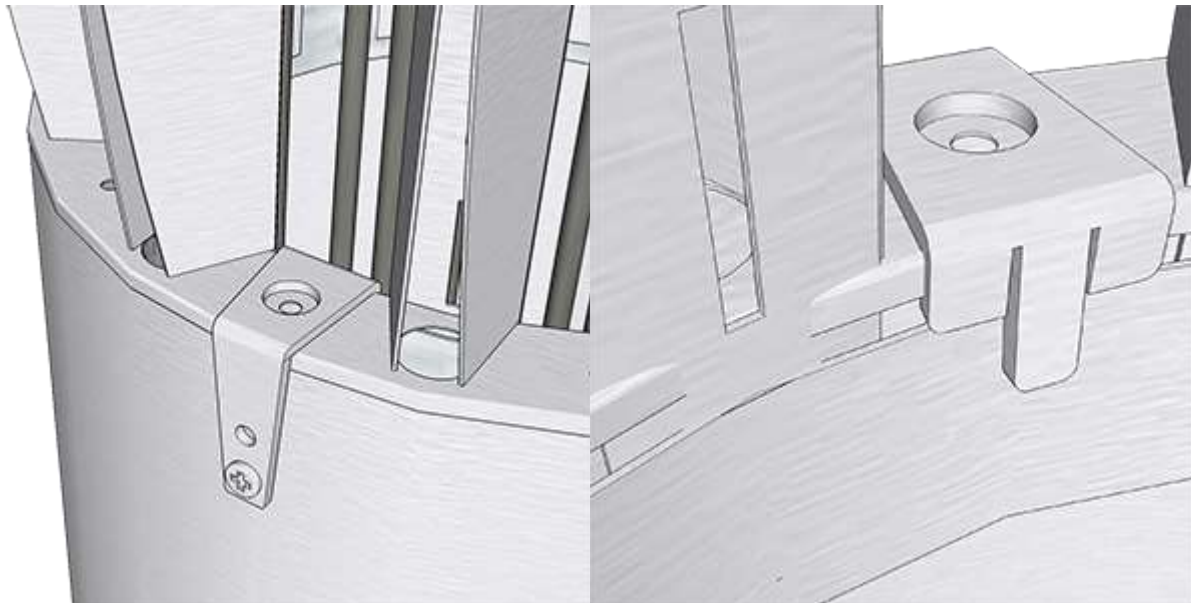

When the lower part of the sauna stove is piled with stones, install the securing bracket of the upper part in all Cenik models and in all 10.5kW models with a high upper part. The external casing of the lower part of the sauna stove has pre-drilled holes for the fastener, and it will be secured with one screw. The bracket will be positioned in line with the smaller hole of the intermediate casing in the Lite/Cenik model, and at the fibre light in the Original model. **In the Lite and Cenik models, the casing must be rotated already before the upper part has been installed in the right place.** The bracket will press the lower band of the upper part downwards, and the upper part will not be able to move or rise upwards.

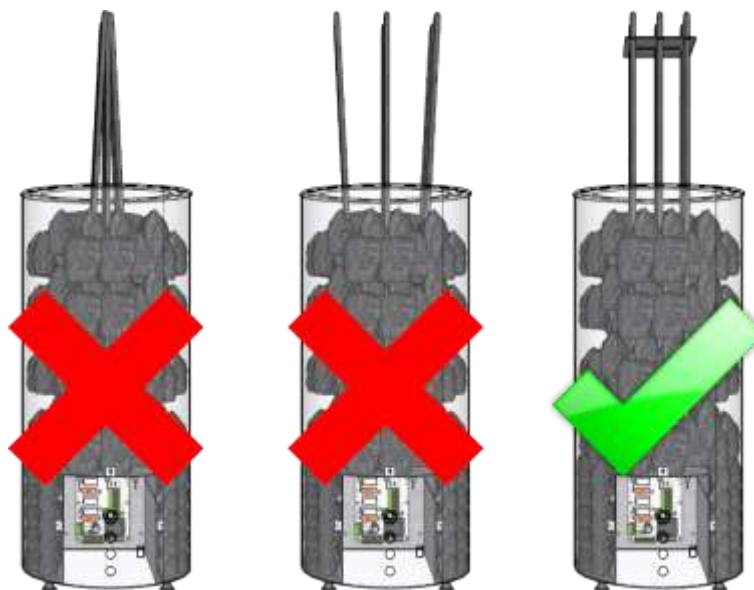

When piling stones in the sauna stove, always ensure that the resistors are straight. **Resistors that are turning outwards can be a fire hazard. Resistors that are turning inwards can burn through prematurely.** If necessary, attach the sauna stove to the wall with the supporting brackets included in the package. A sauna stove with too few stones is a fire hazard! Covering the sauna stove is a fire hazard! The uppermost layer of the stones must be as tight as possible, the resistors must not be visible. We recommend that the sauna stove stones are re-piled on a yearly basis! Always replace burned and cracked stones with new ones. If you use the sauna every day, it is recommended that the stones are piled again every 3 mths. The use of ceramic stones other than (KERKES) is forbidden. Other ceramic stones may cause the resistors to break down prematurely.

4.5 - PILLING THE STONES IN TO HEATER – MAGNUM SADE

Preparations:

1. Ensure that the sauna stove is correctly connected and that the resistors definitely heat up. **Do not pile stones in the sauna stove if the sauna stove does not work fully!**
2. The benches should be installed before the stones are piled in the sauna stove, particularly if the sauna stove is integrated through the benches.
3. Place the sauna stove in its intended location, considering the safety distances. Straighten the sauna stove, using the adjustment feet.
4. For piling stones in the sauna stove, you will need a spirit level, protective gloves, 70 – 150 kg of rocks with a diameter of 5 – 10 cm (depending on the sauna stove model, **see section 5.2**), specifically rocks intended for use in the sauna stove, for example olivine diabase, olivine or peridot. Wash the rocks, if necessary.
5. In the installation illustrations, the parts of the sauna stove have been rendered in different colours and transparent, to make the instructions clearer.

Make sure the stones are not tumbled on the sauna stove bottom. Do not wedge the resistors. Ensure that the resistors remain vertical throughout the entire stoning process. Do not pack the stones tightly. **Ensure that there are stones also between the resistors. Pile stones same way from bottom to top of the heater. Stop when you reach top level of heater.**

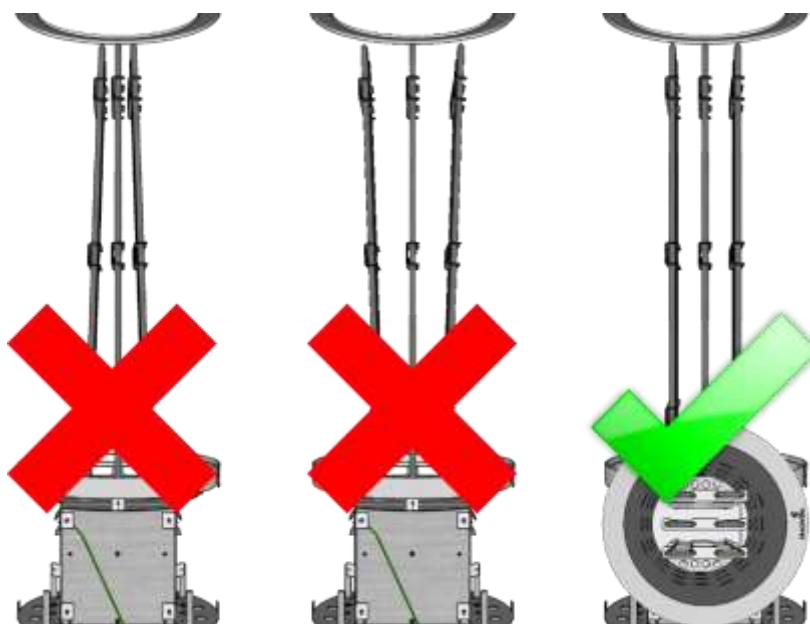

When piling stones in the sauna stove, always ensure that the resistors are straight. **Resistors that are turning outwards can be a fire hazard. Resistors that are turning inwards can burn through prematurely.** If necessary, attach the sauna stove to the wall with the supporting brackets included in the package. A sauna stove with too few stones is a fire hazard! Covering the sauna stove is a fire hazard! The uppermost layer of the stones must be as tight as possible, the resistors must not be visible. We recommend that the sauna stove stones are re-piled on a yearly basis! Always replace burned and cracked stones with new ones. If you use the sauna every day, it is recommended that the stones are piled again every 3 mths. The use of ceramic stones other than (KERKES) is forbidden. Other ceramic stones may cause the resistors to break down prematurely.

4.6– SAUNA STOVE WALL BRACKET

The sauna stove can also be secured to a wall, using the wall brackets included in the package. The bracket is intended to be installed between the gaps on the upper part's profile.

1. Test the fit of the brackets to the sauna stove/wall before attaching to the wall. In Lite/Original/Cenik sauna stoves, the bracket can be installed in the upper band or between the profile. In Sade heater, you can choose any groove outside of the heater.
2. Bend the brackets, if necessary PLEASE NOTE: if you are bending the brackets by hand, use protective gloves.
3. When the bracket seems to be positioned well, mark the attachment points on the wall.
4. Drill a small starting hole at the mark, so that the panel would not crack during the screwing process
5. Place the brackets to the hollows of the upper part of the sauna stove, according to the image, and screw the brackets to the wall
6. Finish piling stones in the sauna stove. The brackets will be covered by the stones.

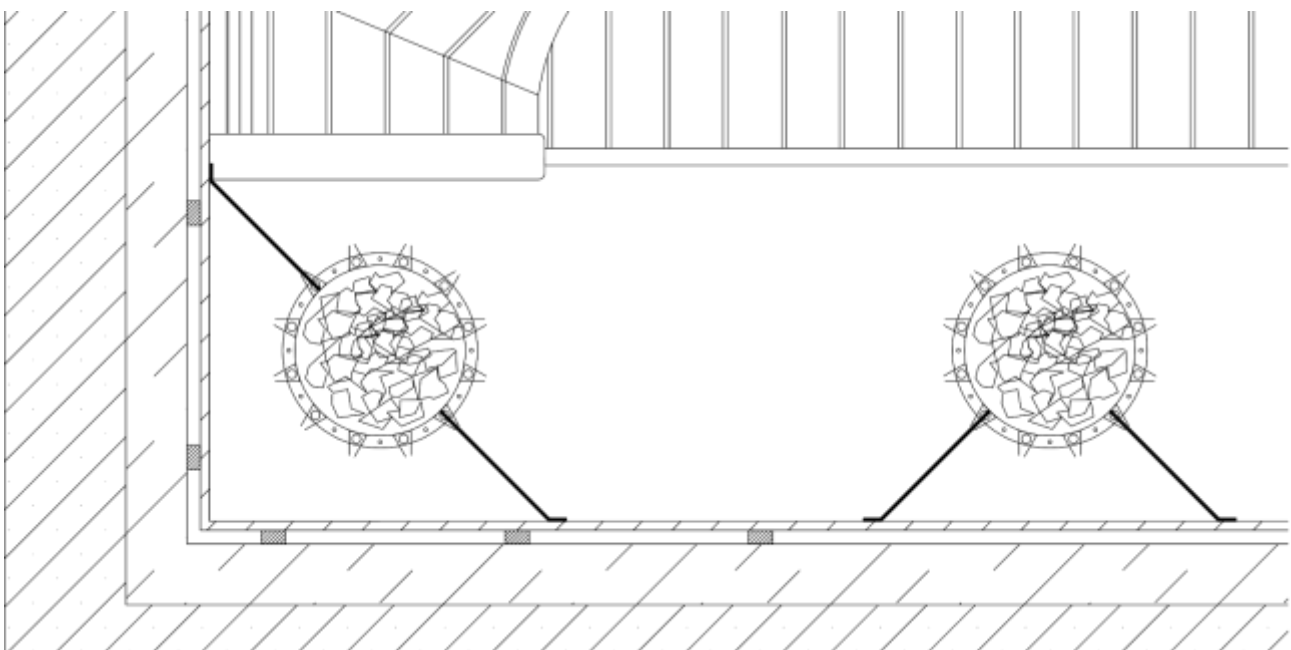
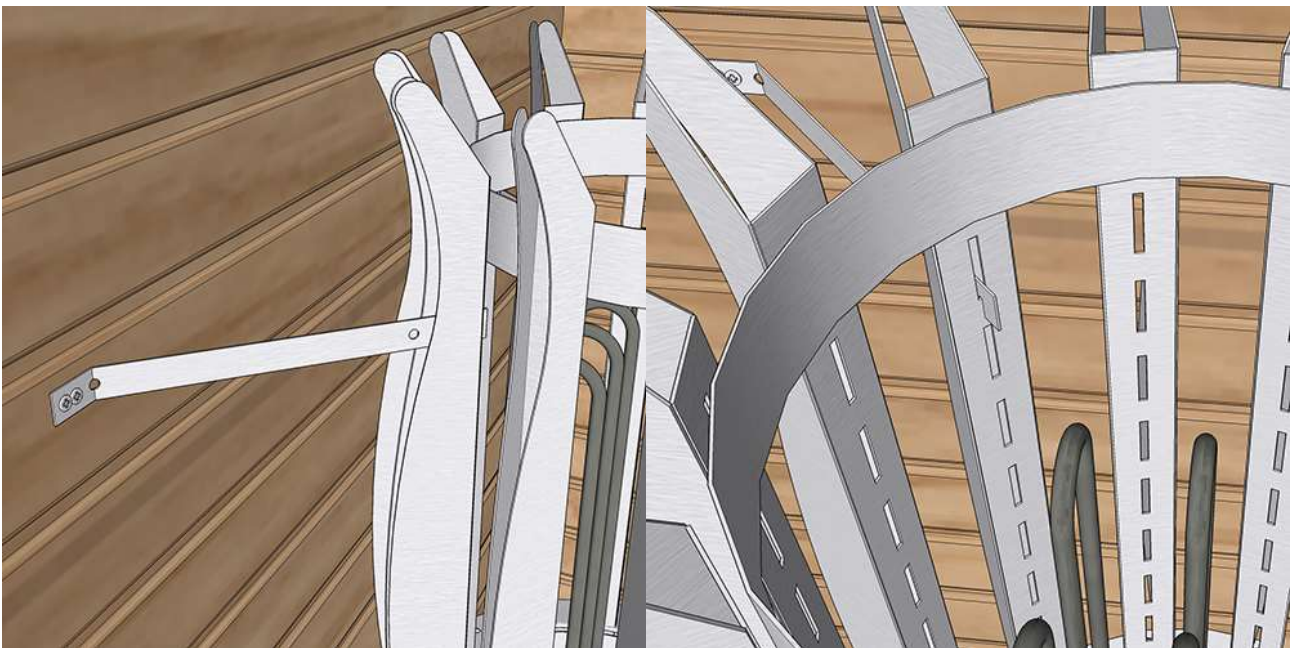

5. TECHNICAL INFORMATION AND SAFETY DISTANCES OF THE SAUNA STOVES

5.1- ILLUSTRATION OF SAFETY DISTANCES

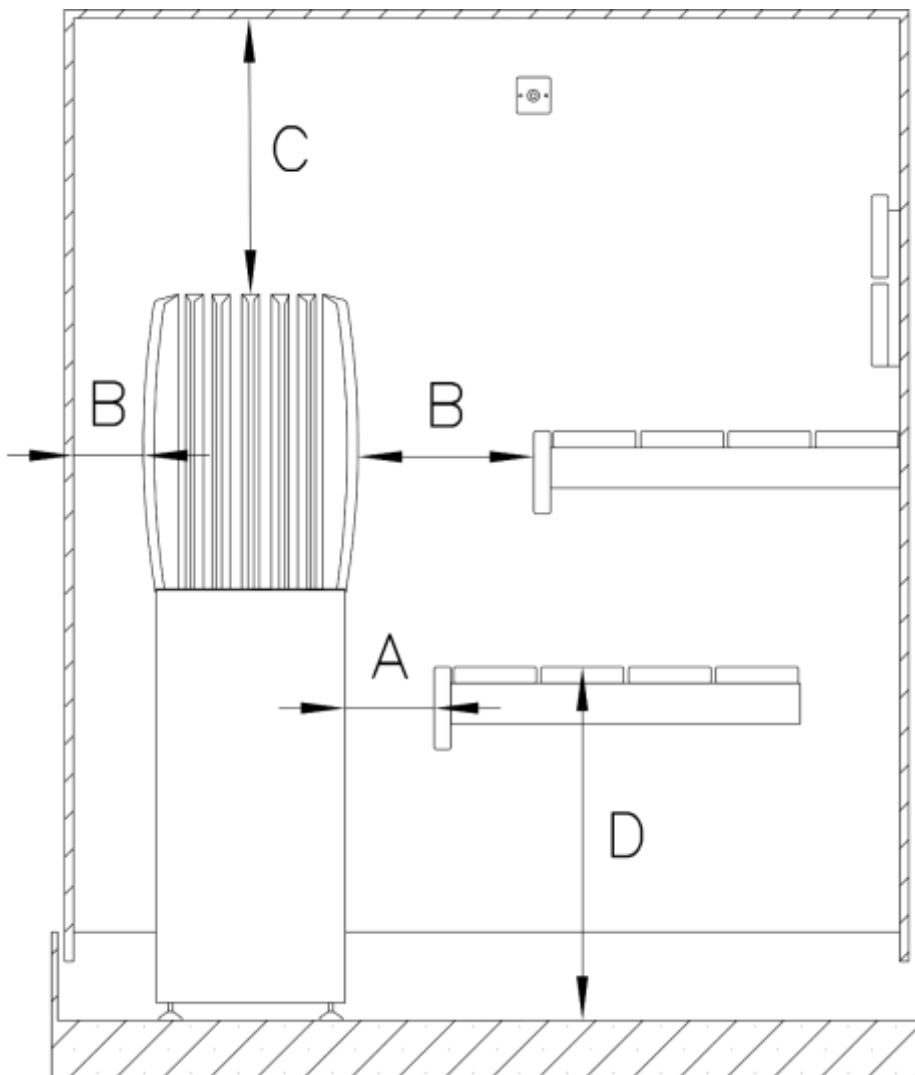

Safety distances to flammable structures	Safety distance Below A	Safety distance Above B	Safety distance to the ceiling C	Safety distance downwards, maximum height D
Magnum Original	20mm	70mm	800mm	700mm
Magnum Lite	50mm	100mm	800mm	700mm
Magnum Cenik	50mm	100mm	800mm	500mm
Magnum Sade	40mm	100mm	1100mm	850mm
PILLAR UPPER PARTS		Pillar UPPER PARTS!		
Magnum Original	20mm	110mm	800mm	700mm
Magnum Lite	50mm	140mm	800mm	700mm
Magnum Cenik	50mm	140mm	800mm	500mm

Reducing safety distances:

- 50% using single protection (1mm metal/fibreboard and 30mm air gap)
- 75% using double protection (double protective covering and air gap)

5.2 - PHYSICAL MEASUREMENTS AND TECHNICAL SPECIFICATIONS OF THE SAUNA STOVES

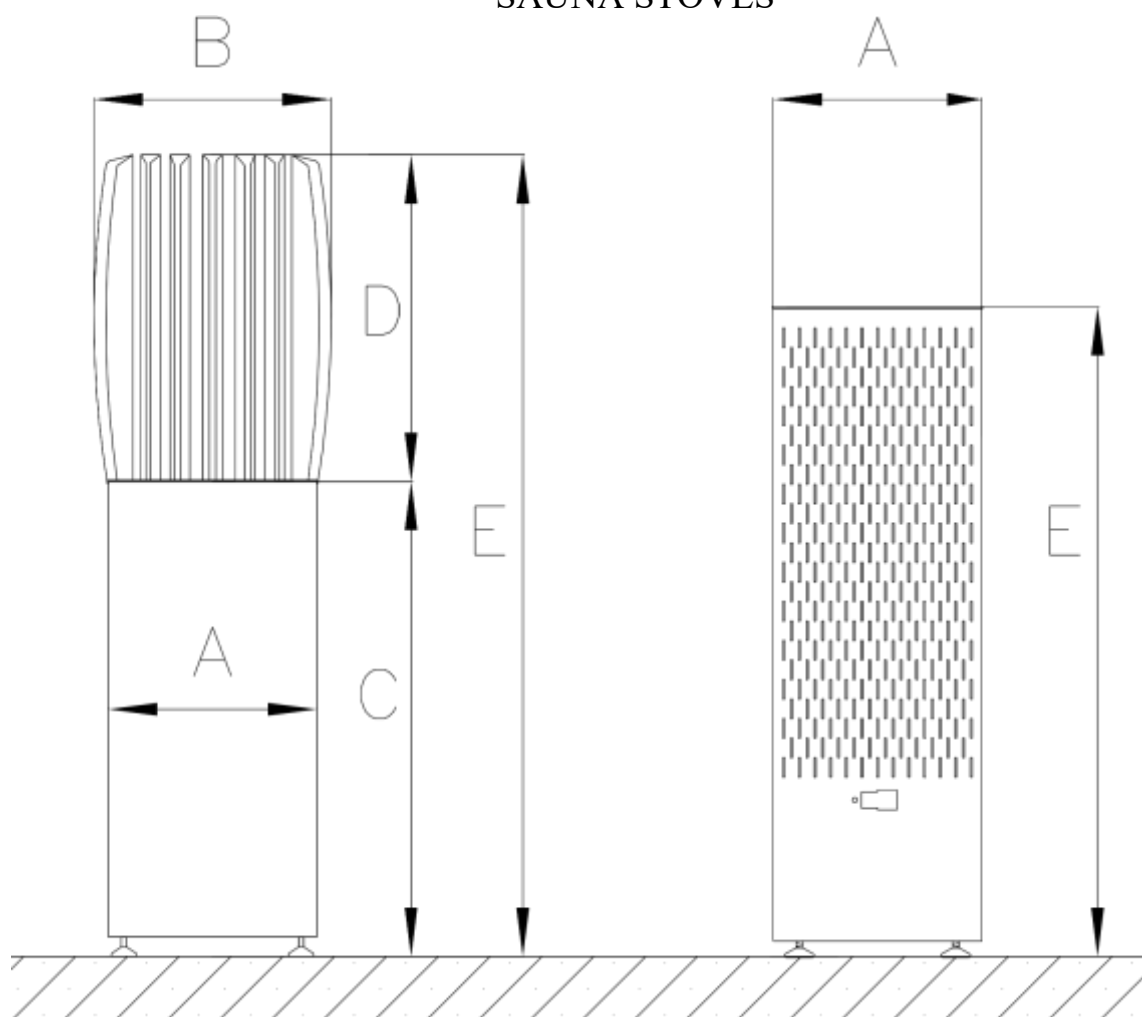

	Original 6	Original 6,6	Original 9,0	Original 10,5
Capacity	6,0 KW	6,6 KW	9,0 KW	10,5 KW
Diameter of the lower part A	320 mm	320 mm	320 mm	320 mm
Diameter of the upper part B	320-395 mm *	320-360 mm *	320-360 mm *	320-385 mm *
Height of the lower part C	730 mm	730 mm	730 mm	730 mm
Height of the upper part D	230mm	500-530mm *	500-530 mm *	700-710 mm *
Total height E	960 mm	1270-1300 mm	1270-1300 mm	1440-1450 mm
Sauna dimensions	5-9 m3	5-9 m3	8-15 m3	10-20 m3
Sauna min. height	1760 mm	2070-2100 mm	2070-2100 mm	2240-2250 mm
Fuse	3x10 A	3x10 A	3x16 A	3x16 A
Connection cable	5x1,5 mm ²	5x1,5 mm ²	5x2,5 mm ²	5x2,5 mm ²
Weight without stones	19kg	23kg	23kg	24kg
Stone amount	n.60kg	n.80kg	n.80kg	n.100kg

*Check the upper part diameter in section 5.3

	Sade 6,0	Sade 9,0
Power	6,0 KW	9,0 KW
Total diameter A	325 mm	325 mm
Total height E	980-1000 mm	980-1000 mm
Sauna room size	5-8 m3	8-15 m3
Minium height of sauna	2100 mm	2100 mm
Fuses	3x10 A	3x16 A
Connection cable	5x1,5 mm2	5x2,5 mm2
Weight without stones	20kg	20kg
Stone amount	n.70kg	n.70kg

	Lite 6	Lite 6,6	Lite 9,0	Lite 10,5
Capacity	6,0 KW	6,6 KW	9,0 KW	10,5 KW
Diameter of the lower part A	320 mm	320 mm	320 mm	320 mm
Diameter of the upper part B	320-395 mm *	320-360 mm *	320-360 mm *	320-385 mm *
Height of the lower part C	730 mm	730 mm	730 mm	730 mm
Height of the upper part D	230mm	500-530mm *	500-530 mm *	700-710 mm *
Total height E	960 mm	1270-1300 mm	1270-1300 mm	1440-1450 mm
Sauna dimensions	5-9 m3	5-9 m3	8-15 m3	10-20 m3
Sauna min. height	1760 mm	2070-2100 mm	2070-2100 mm	2240-2250 mm
Fuse	3x10 A	3x10 A	3x16 A	3x16 A
Connection cable	5x1,5 mm2	5x1,5 mm2	5x2,5 mm2	5x2,5 mm2
Weight without stones	15kg	18kg	18kg	20kg
Stone amount	n.70kg	n.90kg	n.90kg	n.110kg

*Check the upper part diameter in section 5.3

	Cenik 6,6	Cenik 9,0
Capacity	6,6 KW	9,0 KW
Diameter of the lower part A	320 mm	320 mm
Diameter of the upper part B	320-370 mm *	320-370 mm *
Height of the lower part C	530 mm	530 mm
Height of the upper part D	700-710mm	700-710 mm
Total height E	1200-1210 mm	1200-1210 mm
Sauna dimensions	5-9 m3	8-15 m3
Sauna min. height	2000-2010 mm	2000-2010 mm
Fuse	3x10 A	3x16 A
Connection cable	5x1,5 mm2	5x2,5 mm2
Weight without stones	20kg	20kg
Stone amount	n.90kg	n.90kg

*Check the upper part diameter in section 5.3

5.3-UPPER PARTS: SIZE TABLE

Upper part	Width	Height
Original/Lite Vase 6,6kW sekä 9,0kW	360mm	530mm
Original/Lite Vase 10,5kW	370mm	700mm
Original/Lite Tulip 6,6kW sekä 9,0kW	360mm	500mm
Original/Lite Tulip 10,5kW	370mm	700mm
Original/Lite Pillar 6,6kW sekä 9,0kW	320mm	530mm
Original/Lite Pillar 10,5kW	320mm	710mm
Original/Lite Reed 10,5kW	370mm	710mm
Original/Lite 10.5 kW Arrow	385mm	700mm
Original/Lite 6,0kW Swan	395mm	230mm
Original/Lite 6,0kW Vase	360mm	230mm
Cenik Vase 6,6kw and 9,0kW	370mm	700mm
Cenik Tulip 6.6 kW and 9.0 kW	370mm	700mm
Cenik Pillar 6.6kW and 9,0kW	370mm	710mm
Cenik Reed 6.6 kW and 9.0 kW	370mm	710mm

6. WARRANTY – TERMS APPLY ONLY IN FINLAND

Starsauna Oy (the manufacturer) grants warranty for the products it manufactures according to these terms and conditions. For private/apartment use, the warranty period is **24 mths** from the delivery date. The receipt, the order confirmation about the purchase of the sauna stove, the receipt log of the construction site or other corresponding material can all be used as the warranty certificate.

Starsauna Oy guarantees the quality and functionality of the sauna stoves during the warranty period. The warranty requires that the manufacturer's instructions are followed carefully. The warranty does not cover faults caused by incorrect installation and/or incorrect use.

Warranty terms and conditions:

- For sauna stoves in apartment use, the sauna stove stones are piled/replaced at least once a year. Damaged stones must always be replaced when piling the stove with stones again, but we recommend replacing the stones every time.
- The manufacturer's instructions have been followed when piling stones in the sauna stove **CHAPTER 4.4**
- The sauna stove's centre has been installed and connected to the power supply by a licensed company/technician with a valid qualification regarding electrical installations. The installation must have been completed in accordance with the installation instructions. No ceramic stones are used in the sauna stove. If ceramic stones have been used, the warranty is not binding for the manufacturer to compensate for any damage caused by ceramic stones.
- Under no circumstances is the manufacturer liable for direct or indirect damage such as loss of production, decrease in profit, loss of profit, loss of contracts or loss of benefit.
- The sauna stove is always controlled by its own control system.
- In case of a possible fault situation, the product must never be dismantled, or attempted to repair without the manufacturer's permission and/or instructions. If the centre or another control device has been dismantled, the manufacturer reserves the right not to replace the product or the part of the product in question during the warranty period. The manufacturer may charge for possible spare parts, if a warranty term has been breached. When troubleshooting for issues outside the scope of the manual, the buyer should inquire the manufacturer about possible solutions to the problem before replacing all components.
- In troubleshooting situations, the manufacturer will not compensate for the dismantling of any sauna equipment during repair work done on the sauna stove. E.g. benches.
- In troubleshooting situations, the warranty does not cover the removing/re-positioning of the sauna stove stones.
- With regard to repair work covered by the warranty, Starsauna Oy will compensate any installation technician expenses up to the amount of one hundred (100€) Euros. This includes travel expenses and work on site. The compensation is paid when the defective product has been returned to the manufacturer, and deemed to be defective due to the manufacturer's fault. Compensation is not paid for those work hours used for troubleshooting before calling technical support. If the defective part is not returned, no compensation is paid. Neither is compensation paid if the damage has occurred due to misuse or incorrect connection. In these cases, the manufacturer can charge the full price from the buyer, according to the spare parts price list. The compensation claim must be submitted to the manufacturer in writing, and it must include the warranty certificate of the sold product, with the sales date specified on it. The receipt, the order confirmation about the purchase of the sauna stove, the receipt log of the construction site or other corresponding material can all be used as the warranty certificate.
- Returning spare parts to the manufacturer is carried out at the buyer's expense. Starsauna will pay for the freight of the spare parts to be delivered to the buyer.
- The warranty period for replacement parts is 6 mths from the date of delivery.
- In cases of repair, the manufacturer's warranty is limited only to repairing or replacing the centre, it does not extend to any other electrical systems in the building.
- The warranty does not cover blue stains or darkening of the stainless steel, caused by extended heating times and high temperatures.

Institutional/Professional use

Starsauna Oy grants sauna stoves a 3-month warranty in institutional/professional use. Institutional use denotes premises which are kept hot constantly, e.g. swimming pools, gyms, etc. It is not recommended to keep the sauna stove turned on for more than six (6) hours at a time.

7. CONNECTION DIAGRAM

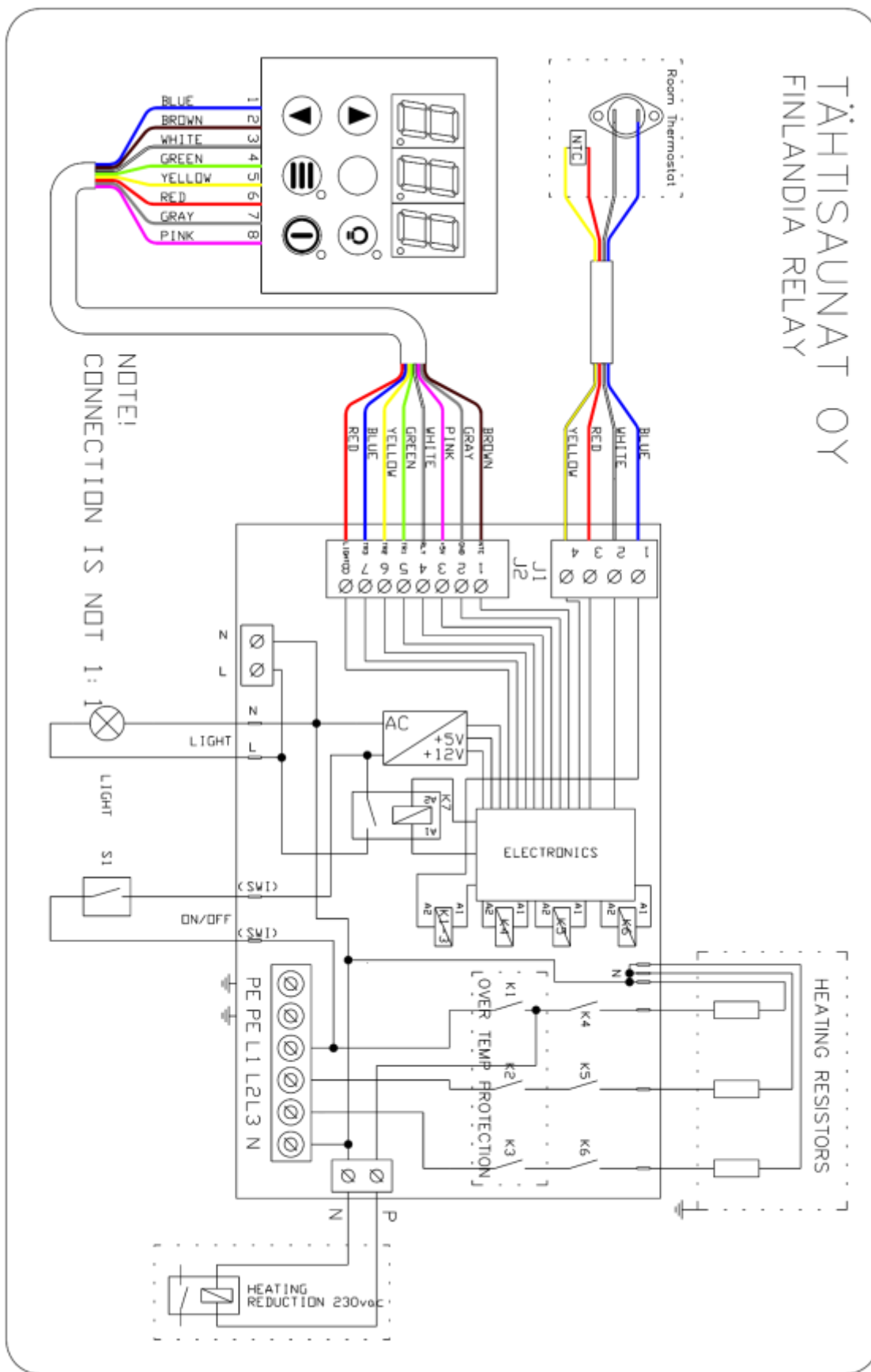

8. SAUNA STOVE CARE AND MAINTENANCE

Stove stones are most important aspect of sauna stove maintenance, and they have to be replaced regularly. The thermal capacity and thermal conductivity of the stove stones decrease over time, and the stones will start to crumble. **The most common reason for the resistors breaking is not replacing the sauna stove stones often enough.** As a result of the temperature variations, the sauna stove stones settle and the mass sinks, which can damage the resistors. The hot wire inside the resistor cannot withstand excessive twisting or bending. Consequently, the resistor could be broken on the inside although it might look completely intact. It is recommended to re-pile the stones at least once a year, replacing any cracked stones with new ones and washing the dust off the old usable stones. If you have a sauna every day, it is advisable to re-pile the stones every three months.

There can be a lime build-up on the sauna stove from the water thrown on the rocks; it must be cleaned either with cleaning wipes made for stainless steel, or mechanically with extra fine steel wool. The upper part can be washed for example with cloths made for cleaning stoves. If you use chemicals to wash the sauna stove, make sure that all chemicals are rinsed off before the next heating time, and the stones must not be subject to any superfluous substances. In other words, always remember to remove the stones before using any chemicals.

Below, you can keep a track of the sauna stove stone replacements and other maintenance measures. The manufacturer has the right to obtain information about all maintenance measures for warranty purposes. We recommend keeping the receipts for any purchased stones etc.

Maintenance history.

Päivämäärä	Toimenpide



9. PROBLEMS/TROUBLESHOOTING GUIDE

Why is the sauna stove not heating up?

Check the following:

1. Is the power on and the control switch in position I (**Chapter 2.5**)?
2. Is the adjusted temperature higher than the temperature of the sauna?
3. Has the temperature limiter gone off? (The cause must be determined before the next use)
4. Are the fuses on the building's switchboard intact?
5. Is there an error code on the control panel display? If the device malfunctions, the display will show an error code. You can attempt to solve the problem with the following error codes. If the problem is not solved with these instructions, contact technical support or maintenance.

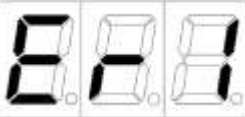
Error codes will not be displayed after the error situation has been resolved. E.g. when the sensor short circuit has been dealt with or if the device has cooled sufficiently after overheating. After that, you can try to switch the device on again.

Error code / symptom:	Legend:
	ER1 = There is no heat sensor or the temperature is too low. Check the heat sensor's cabling and installation.
	ER2 = Heat sensor has short-circuited or the temperature is too high. Check the heat sensor's cabling and ensure that the sensor is intact and that there are no short circuits. Also check the Finlandia centre's wiring on page 14.
	The temperature in the device's control electronics is too high. See the previous part.
No error codes on the screen, but the sauna is not heating up.	Check the overheating protection and ensure that it has not gone off. The overheating protection may be turned off by carefully pressing the button in the heat sensor box.
The stove light does not work	First confirm that the sauna stove's model features lights. If the light is not turned on, contact technical support.
The sauna stove does not heat properly	Remove the stones and check the condition of the resistors. If the resistors are in working condition, contact technical support.



MAGNUM[®]

Copyright Tähtisaunat Oy – We reserve the right to make changes

Tähtisaunat Oy
Pistotie 4
15860 Hollola, Finland
info@magnumkivas.fi
www.tahtisaunat.fi

CE

IPX4

